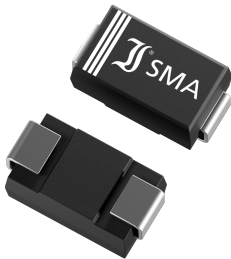

Z1SMA1 ... Z1SMA100
SMD Zener Diodes (non-planar technology)
Flächendiffundierte SMD Zener-Dioden

$P_{tot@T_T=75^\circ C} = 1.5 \text{ W}$
 $V_Z = 1 \text{ V} \dots 100 \text{ V}$
 $T_{jmax} = 150^\circ C$

Version 2021-08-03

SMA
 ~ DO-214AC

SPICE Model & STEP File ¹⁾

Marking
 Zxx where xx = V_Z
 Zxx mit xx = V_Z

HS Code 85411000**Typical Applications**

Voltage stabilization and regulators
 (For overvoltage protection – uni- and bi-directional – see TVS series P4SMA)
 Commercial grade
 Suffix -Q: AEC-Q101 compliant ¹⁾
 Suffix -AQ: in AEC-Q101 qualification ¹⁾

Features

High power dissipation
 V_Z specified at 5 mA
 V_Z up to 100 V
 Compliant to RoHS (exemp. 7a)
 REACH, Conflict Minerals ¹⁾

**Mechanical Data ¹⁾**

Taped and reeled 7500 / 13"
 Weight approx. 0.07 g
 Case material UL 94V-0
 Solder & assembly conditions 260°C/10s
 MSL = 1

Typische Anwendungen

Spannungsstabilisierung und -regler
 (Für Überspannungsschutz – uni- und bidirektional – s. TVS-Reihe P4SMA)
 Standardausführung
 Suffix -Q: AEC-Q101 konform ¹⁾
 Suffix -AQ: in AEC-Q101 Qualifikation ¹⁾

Besonderheiten

Hohe Leistungsfähigkeit
 V_Z bei 5 mA spezifiziert
 V_Z bis zu 100 V
 Konform zu RoHS (Ausn. 7a)
 REACH, Konfliktminerale ¹⁾

Mechanische Daten ¹⁾

Gegurtet auf Rolle
 Gewicht ca.
 Gehäusematerial
 Löt- und Einbaubedingungen

Standard Zener voltage tolerance is graded to the international E 24 ($\sim \pm 5\%$) standard.
 Zener voltages see table on next page. Other voltage tolerances and higher Zener voltages on request.

Die Toleranz der Zener-Spannung ist in der Standard-Ausführung gestuft nach der internationalen Reihe E 24 ($\sim \pm 5\%$).
 Zener-Spannungen siehe Tabelle auf der nächsten Seite. Andere Toleranzen oder höhere Arbeitsspannungen auf Anfrage.

Maximum ratings ²⁾**Grenzwerte ²⁾**

Power dissipation Verlustleistung	$T_A = 50^\circ C$ $T_T = 75^\circ C$	P_{tot}	1 W ³⁾ 1.5 W ⁴⁾
Operating junction temperature – Sperrschichttemperatur Storage temperature – Lagerungstemperatur		T_j T_s	-50...+150°C -50...+175°C

Characteristics**Kennwerte**

Typical thermal resistance junction to ambient Typischer Wärmewiderstand Sperrschicht – Umgebung		R_{thA}	70 K/W ³⁾
Typical thermal resistance junction to terminal Typischer Wärmewiderstand Sperrschicht – Anschluss		R_{thT}	30 K/W
Forward voltage – Durchlass-Spannung	$I_F = 200 \text{ mA}$ $T_j = 25^\circ C$	V_F	< 1 V

- Please note the [detailed information on our website](#) or at the beginning of the data book
Bitte beachten Sie die [detaillierten Hinweise auf unserer Internetseite](#) bzw. am Anfang des Datenbuches
- $T_A = 25^\circ C$ unless otherwise specified – $T_A = 25^\circ C$ wenn nicht anders angegeben
- Mounted on P.C. board with 25 mm² copper pad per terminal – Montage auf Leiterplatte mit 25 mm² Kupferpad je Anschluss
- Mounted on P.C. board with 1 in² (625 mm²) copper pad per terminal
Montage auf Leiterplatte mit 1 in² (625 mm²) Kupferpad je Anschluss
- Tested with pulses – Gemessen mit Impulsen
- The Z1SMA is a diode operated in forward mode. Hence, the index of all parameters should be "F" instead of "Z".
The cathode, indicated by a white band, has to be connected to the negative pole.
Die Z1SMA ist eine in Durchlass betriebene Si-Diode. Daher ist bei allen Kenn- und Grenzwerten der Index "F" anstatt "Z" zu setzen. Die mit weißem Balken gekennzeichnete Kathode ist mit dem Minuspol zu verbinden.

Characteristics

 (T_j = 25°C unless otherwise specified)

Kennwerte

 (T_j = 25°C wenn nicht anders spezifiziert)

Type Typ	Zener voltage ⁴⁾ Zener-Spannung ⁴⁾ I _Z = 5 mA		Dynamic resistance Inhär. diff. Widerstand r _{zj} [Ω] at f = 1 kHz		Temp. Coeffic. of Z-voltage ...der Z-spannung	Reverse voltage Sperrspannung I _R = 1 μA	Z-current ³⁾ Z-Strom ³⁾ T _A = 50°C
	V _{Zmin} [V]	V _{Zmax} [V]	I _Z = 5 mA	I _Z = 1 mA			
Z1SMA1 ⁵⁾	0.71	0.82	6.5 (<8)	–	–26...–23	–	500
Z1SMA5.6	5.2	6.0	10 (<40)	< 500	–7...–3	> 0.5 / 3 μA	167
Z1SMA6.2	5.8	6.6	4.8 (<11)	< 300	–6...–1	> 1.5	152
Z1SMA6.8	6.4	7.2	4.5 (<10)	< 300	–5...+2	> 2	139
Z1SMA7.5	7.0	7.9	4.0 (<8)	< 100	–3...+4	> 2	127
Z1SMA8.2/-Q	7.7	8.7	4.5 (<10)	< 50	–2...+6	> 3.5	115
Z1SMA9.1	8.5	9.6	4.8 (<11)	< 50	–1...+7	> 3.5	104
Z1SMA10	9.4	10.6	5.2 (<15)	< 70	+2...+7	> 5	94
Z1SMA11	10.4	11.6	6 (<20)	< 70	+3...+7	> 5	86
Z1SMA12/-Q	11.4	12.7	7 (<20)	< 90	+4...+7	> 7	79
Z1SMA13	12.4	14.1	9 (<25)	< 110	+5...+8	> 7	71
Z1SMA15/-Q/-AQ	13.8	15.6	11 (<30)	< 110	+5...+8	> 10	64
Z1SMA16/-Q	15.3	17.1	13 (<40)	< 170	+5...+9	> 10	58
Z1SMA18/-Q/-AQ	16.8	19.1	18 (<50)	< 170	+6...+9	> 10	52
Z1SMA20/-Q	18.8	21.2	20 (<50)	< 220	+7...+9	> 15	47
Z1SMA22	20.8	23.3	25 (<55)	< 220	+7...+9	> 17	43
Z1SMA24/-Q	22.8	25.6	28 (<80)	< 220	+7...+9.5	> 18	39
Z1SMA27	25.1	28.9	30 (<80)	< 250	+8...+9.5	> 20	35
Z1SMA30	28	32	35 (<80)	< 250	+8...+9.5	> 22.5	31
Z1SMA33	31	35	40 (<80)	< 250	+8...+10	> 25	29
Z1SMA36	34	38	40 (<90)	< 300	+8...+10	> 27	26
Z1SMA39/-Q	37	41	50 (<90)	< 500	+8...+10	> 29	24
Z1SMA43	40	46	60 (<100)	< 700	+8...+10	> 32	22
Z1SMA47	44	50	70 (<100)	< 750	+8...+10	> 35	20
Z1SMA51	48	54	70 (<100)	< 750	+8...+10	> 38	19
Z1SMA56	52	60	70 (<100)	< 750	+9...+11	> 42	17
Z1SMA62	58	66	80 (<110)	< 750	+9...+11	> 47	15
Z1SMA68	64	72	90 (<140)	< 750	+9...+12	> 51	14
Z1SMA75	70	79	95 (<150)	< 750	+9...+12	> 56	13
Z1SMA82	77	88	100 (<170)	< 750	+9...+12	> 62	11
Z1SMA91	85	96	130 (<200)	< 800	+10...+12	> 68	10
Z1SMA100	94	106	200 (<300)	< 800	+10...+12	> 75	9

3,4,5 Notes see previous page – Fußnoten siehe vorhergehende Seite

Z1SMA1 ... Z1SMA100

Dimensions – Maße [mm]

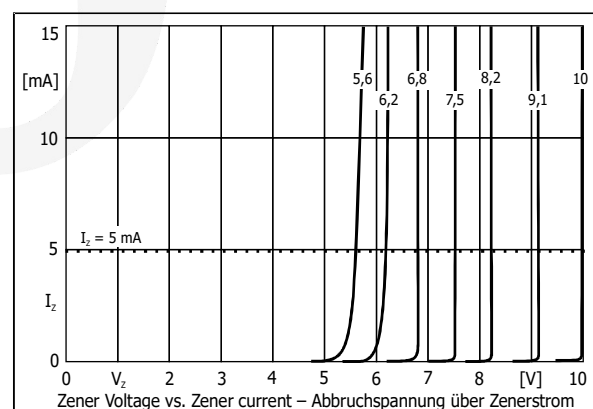
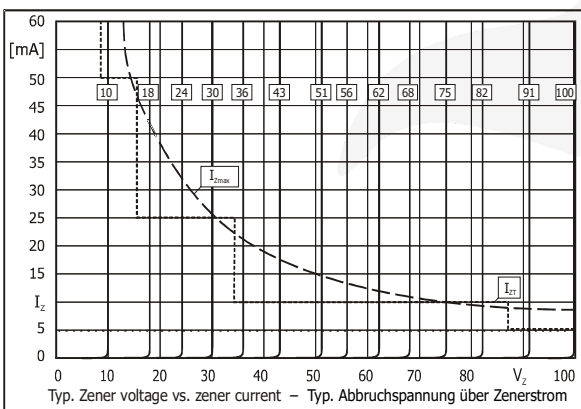
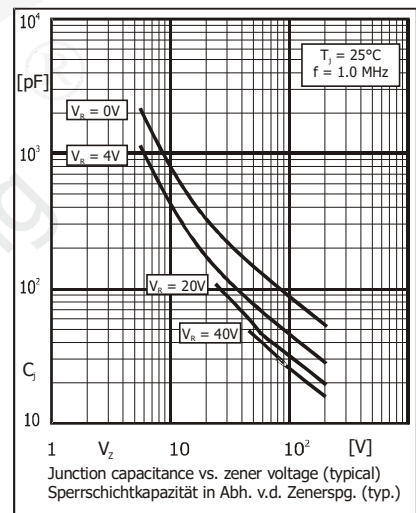
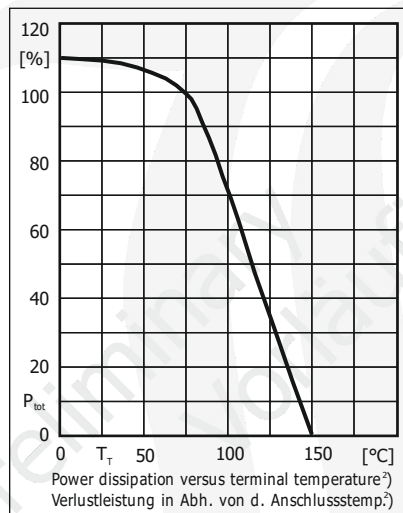
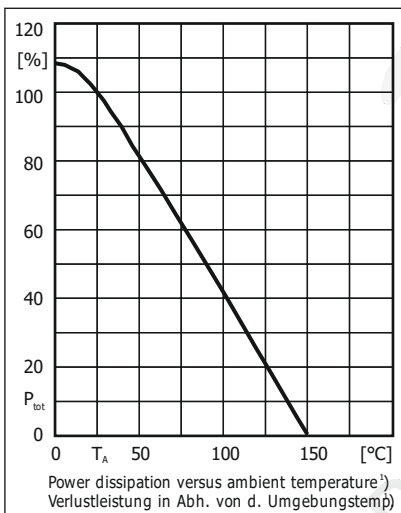
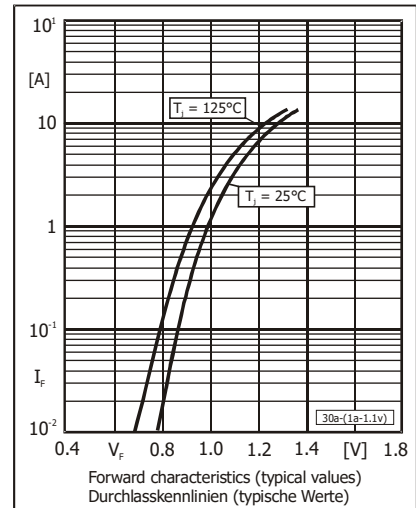
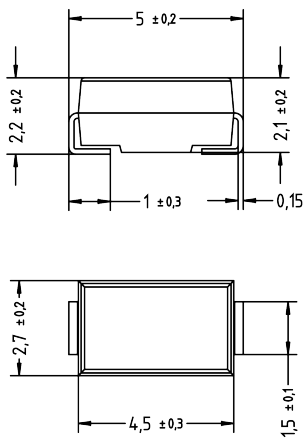

Disclaimer: See data book page 2 or [website](#)
Haftungsausschluss: Siehe Datenbuch Seite 2 oder [Internet](#)

- 1 Mounted on P.C. board with 25 mm² copper pad per terminal – Montage auf Leiterplatte mit 25 mm² Kupferpad je Anschluss
- 2 Mounted on P.C. board with 1 in² (625 mm²) copper pad per terminal
Montage auf Leiterplatte mit 1 in² (625 mm²) Kupferpad je Anschluss