

1. Scope of Application

These specifications are applied to the chip type LED lamp , model CL-L330-MC26L1-C

2. Part code

CL - L330 - MC26L1 - C

Series

L330 : White power LED for general lighting.

Special specifications

M : General Color Rendering Index Typ. 83 Type.

Watt Class

C26 : 26 watt package.

Lighting color

L1 : Energy Star Correlated Color Temperature 3000(K)

Symbol	CITILED
Name	CL-L330-MC26L1-C
CITIZEN ELECTRONICS CO.,LTD. JAPAN	

3. Outline drawing

Unit : mm

Tolerances unless otherwise specified : ±0.3

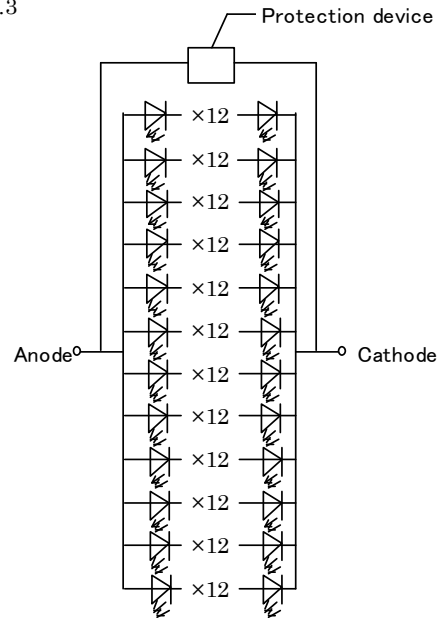
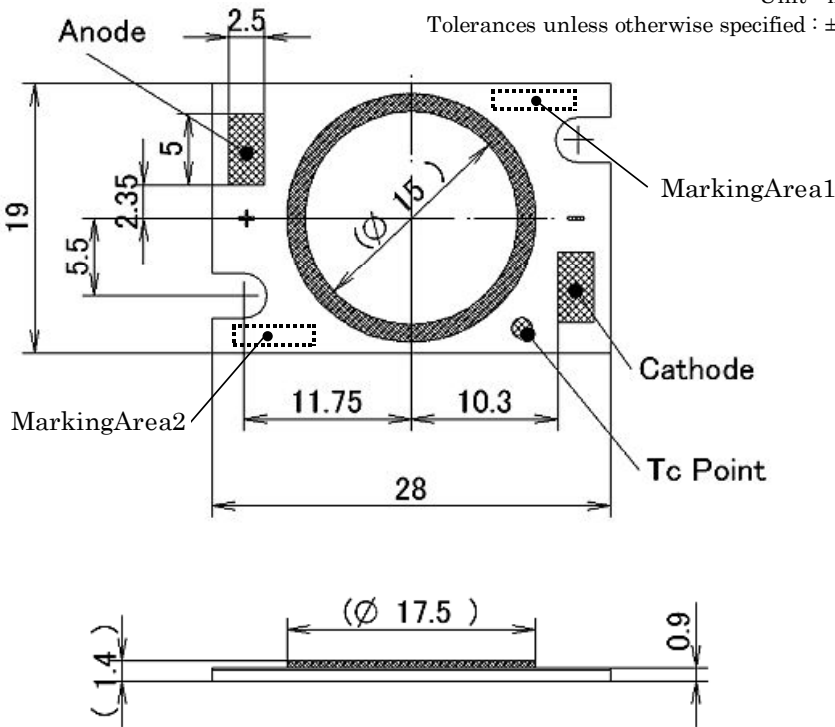

Marking1 : Serial No.

Marking2 : M 26 L1 C

Color L1 : 3000K
Watt 26 : 26 W
Ra M : Typ.83

4. Performance

(1) Absolute Maximum Rating

Parameter	Symbol	Rating Value	Unit
Power Dissipation	P_D	35.8	W
Forward Current	I_F	840	mA
Forward Pulse Current	I_{FP}	1,200	mA
Reverse Current	I_R	1	mA
Operating Temperature	T_{OP}	-30 ~ +85	C
Storage Temperature	T_{ST}	-40 ~ +100	C
Junction Temperature	$T_{j \text{ Max}}$	120	C

*1 Forward Current : Duty≤1/10 , Pulse Width≤10msec

*2 D.C. Current : $T_j = T_c + R_{j-c} \times P_D$

Pulse Current : $T_j = T_c + R_{j-c} \times Pw(\text{Power Dissipation / one-Pulse}) \times \text{Duty}$

Symbol	CITLED
Name	CL-L330-MC26L1-C
CITIZEN ELECTRONICS CO.,LTD. JAPAN	

(2) Electro-optical Characteristics

(Tc=25 C)

Parameter	Symbol	Condition	Min.	Typ.	Max.	Unit
Forward Voltage	V _F	I _F =720mA	34.8	37.2	42.0	V
Luminous Flux	Φ _v	I _F =720mA	1660	1960	-	lm
General Color Rendering Index	Ra	I _F =720mA	80	83	-	-
Thermal Resistance	R _{j-c}	Junction-case	-	1.7	-	C/W

Chromaticity coordinates (Condition : I_F=720mA , Tc=25 C)

Color rank	Center	
	x	y
L1	0.4338	0.4030
	Oval parameter	
	a	0.00834
	b	0.00408
	θ°	53.17

Reference (ANSI C78.377)

Color rank	x	y	
L1	Center	0.4338	0.4030
	a	0.4562	0.4260
	b	0.4299	0.4165
	c	0.4147	0.3814
	d	0.4373	0.3893

(3045K)

*Color region stay within MacAdam "3-step" ellipse from the chromaticity center.

*The chromaticity center refers to ANSI C78.377:2008.

Please refer to ANSI C78.377 for the chromaticity center.

*θ is the angle between the major axis of the ellipse and the x-axis,

and a and b are the major and minor semi-axes of an ellipse. (Ref. IEC 60081:1997 AnnexD)

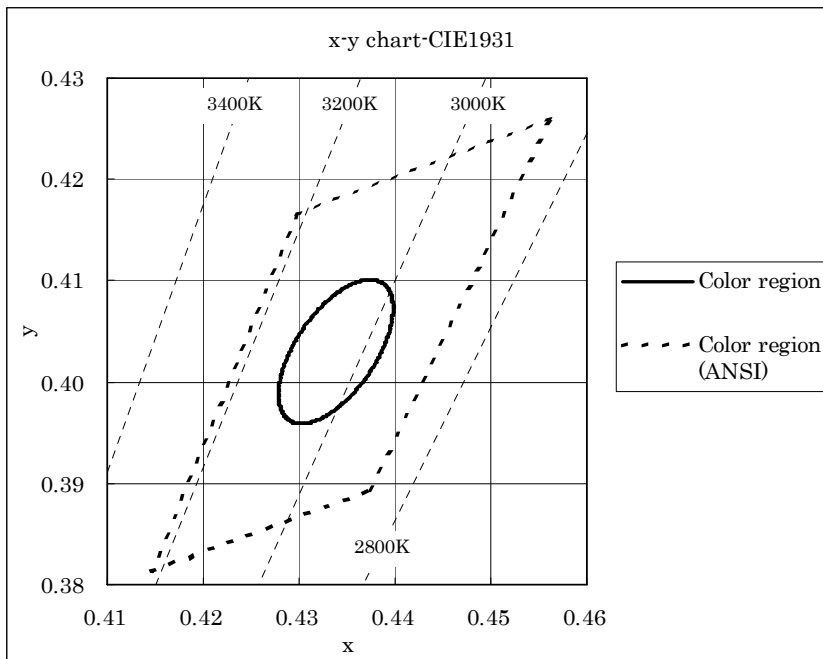

Note: The tolerance of measurement at our tester is V_F+/-3% , Φ_v+/-10% , Chromaticity(x,y)+/-0.005 and Ra+/-1.

Symbol	CITLED
Name	CL-L330-MC26L1-C
CITIZEN ELECTRONICS CO.,LTD. JAPAN	

5. Characteristics

• Forward Current vs. Forward Voltage

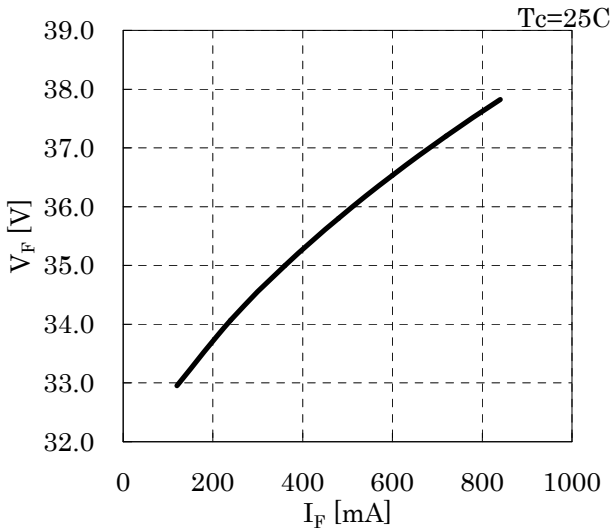

• Forward Current vs. Relative Luminous Flux

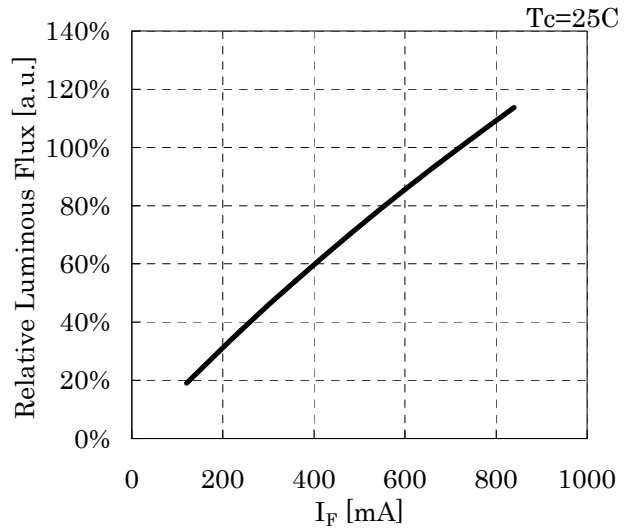

• Forward Current vs. Chromaticity Coordinate

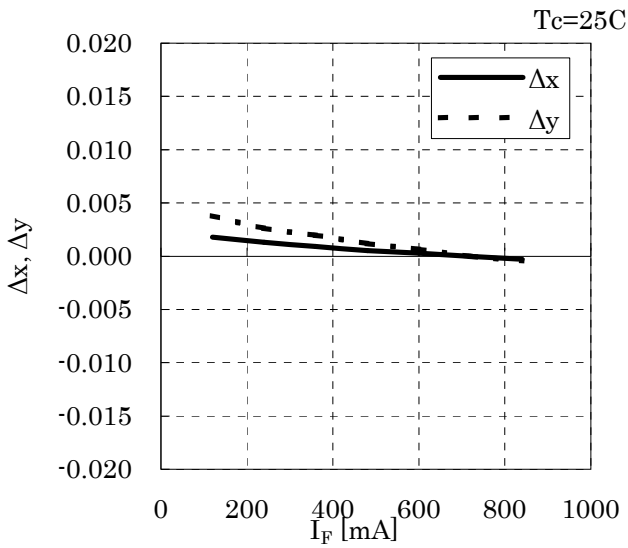

• Case Temperature vs. Chromaticity Coordinate

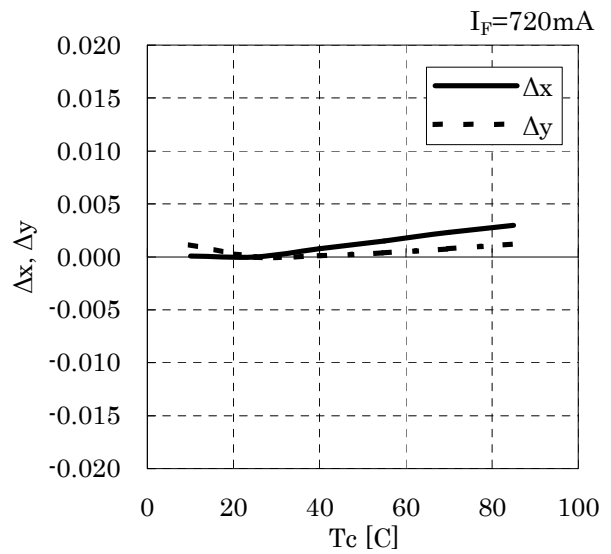

Symbol	CITLED
Name	CL-L330-MC26L1-C
CITIZEN ELECTRONICS CO.,LTD. JAPAN	

•Case Temperature vs. Forward Voltage

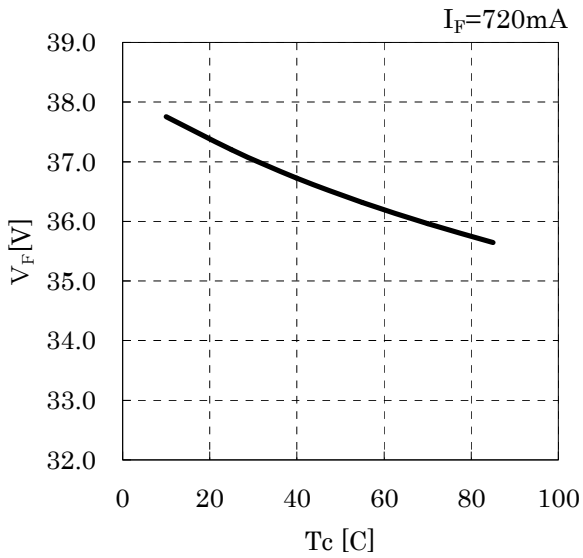

•Case Temperature vs. Relative Luminous Flux

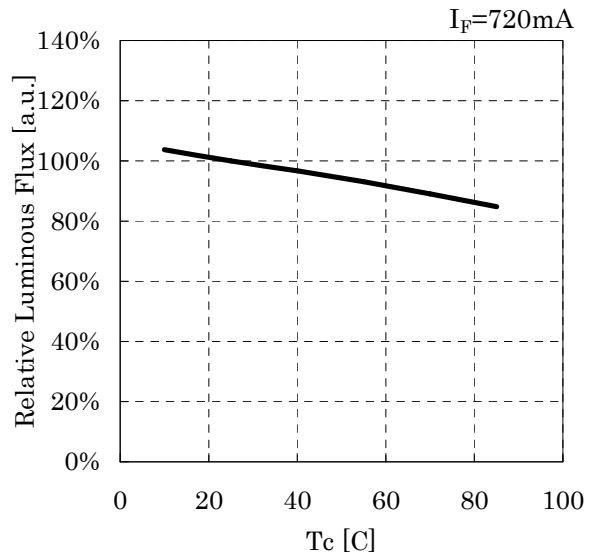

•Case Temperature vs. Allowable Forward Current

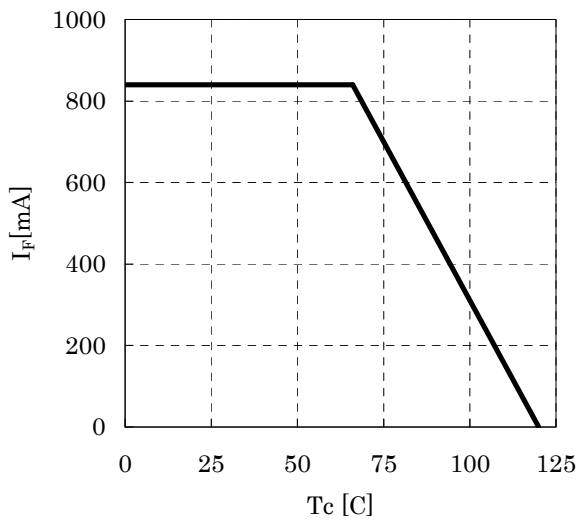

•Spectrum

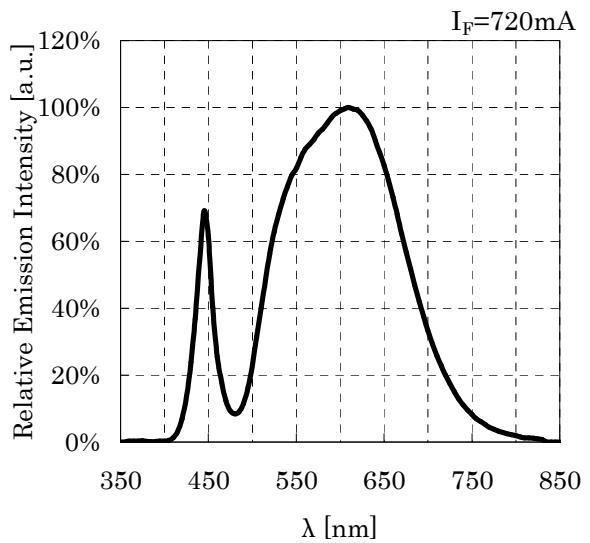

Symbol	CITLED
Name	CL-L330-MC26L1-C
CITIZEN ELECTRONICS CO.,LTD. JAPAN	

6. Reliability

(1) Details of the tests

Test Item	Test Condition
Continuous Operation Test	Ta=25 C, I _F =720 mA× 1000 hours(with Al-fin)
	Ta=85 C, I _F =570 mA× 1000 hours(with Al-fin)
Low Temperature Storage Test	-40 C × 1000 hours
High Temperature Storage Test	100 C × 1000 hours
Moisture-proof Test	85 C, 85 %RH for 1000 hours
Thermal Shock Test	-40 C × 30 minutes – 100 C × 30 minutes, 100 cycle

(2) Judgment Criteria of Failure for Reliability Test (Ta=25 C)

Measuring Item	Symbol	Measuring Condition	Judgment Criteria for Failure
Forward Voltage	V _F	I _F =720mA	> U × 1.1
Total Luminous Flux	Φ _V	I _F =720mA	< S × 0.85

U defines the upper limit of the specified characteristics. S defines the initial value.

Note: Measurement shall be taken between 2 hours and 24 hours, and the test pieces should be returned to the normal ambient conditions after the completion of each test.

Symbol	CITILED
Name	CL-L330-MC26L1-C
CITIZEN ELECTRONICS CO.,LTD. JAPAN	

7. Packing Specifications

(1) Packing

An empty tray is placed on top of a five-tier tray which contain 35 pieces each. The set of six trays is banded together with two rubber bands.

(Smallest packing unit: 175 pieces)

A label with product name, quantity, lot number is placed on the upper empty tray.

Tray (Dimensions: 310 × 210 × 14.6mm / Materials: Electrically conductive PS)

< Packing figure >

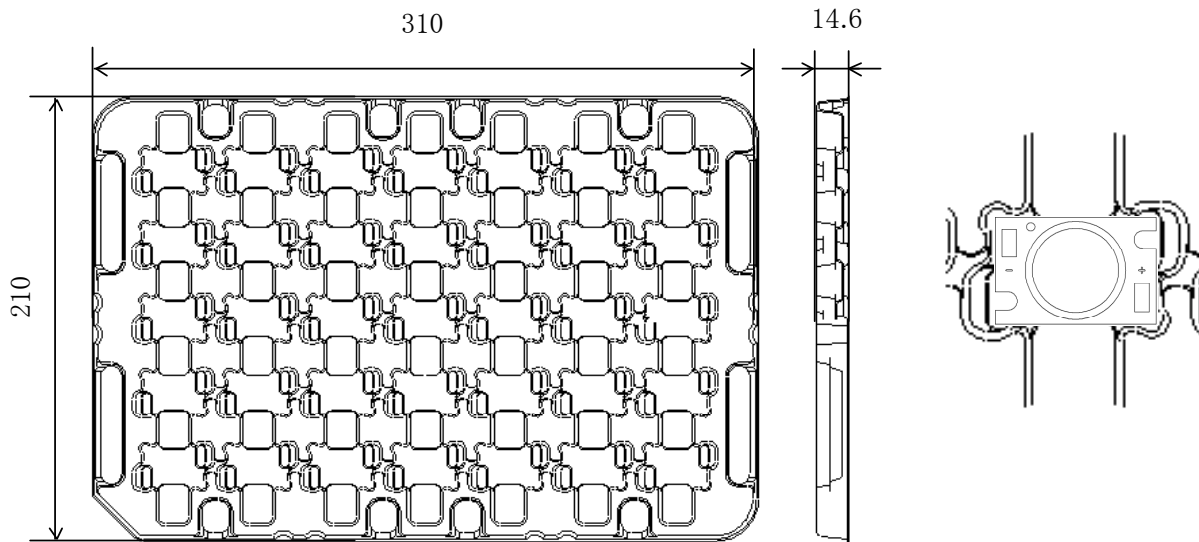

Product 35pcs/tray

< Example of indication label >

CUSTOMER			
TYPE	CL-L330-MC26L1-C	---(1)	 PASS
P.NO	xxx	---(2)	
LOT No	0YD001	---(3)	
Q'ty	175 pcs.	---(4)	
CITIZEN ELECTRONICS			

1. TYPE e.g. CL-L330-MC26L1-C
2. P.No. (Customer's P/N) e.g. xxx
3. Lot No. e.g. 0YD001
 - First letter: Last digit of the year e.g. 0 : year 2010
 - Second letter: Production month e.g. Y : November
 Note: October, November and December are designated by X, Y and Z, respectively.
- Third letter: CE's control number e.g. D001
4. Quantity e.g. 175 pieces

Symbol	CITILED
Name	CL-L330-MC26L1-C
CITIZEN ELECTRONICS CO.,LTD. JAPAN	

8. Precautions

1. Avoid the application of any stress to the resin portion.
2. Avoid any contact by a sharp metal nail or other materials with the resin portion.

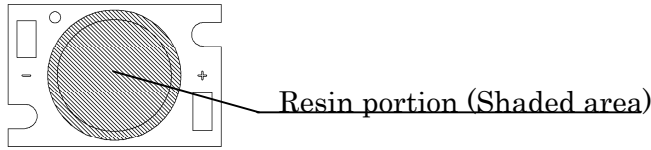

3. This product should be secured firmly by fastening an M3 screw on both sides of the product. Please be careful not to apply any stress to the product during the clamping operation. As the connection status could vary depending on materials of outer heat sink, please check thoroughly.

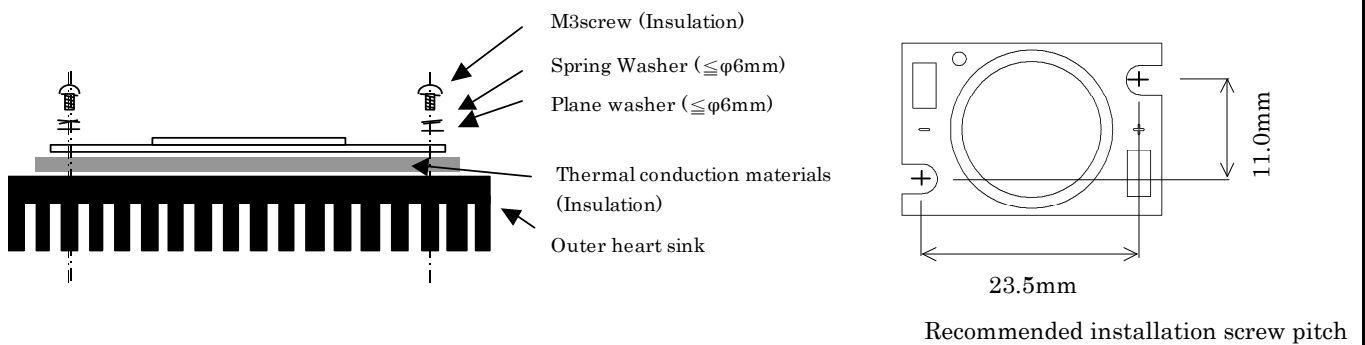

4. Insulation between the terminal section and the heat sink section of the LED is not covered by warranty. With regard to insulation after this product has been assembled in an apparatus, preventive action should be carried out by the customer.
5. For fixing this product to the outer heat sink, heat grease should be applied to the whole rear surface so that the product can dissipate heat as a whole. Please pay attention to avoid product deformation when conducting the clamping operation with heat grease in sheet form.
6. Handling of static electricity
 - These products are sensitive to static electricity charge. Please take measures to prevent any static electricity being produced such as the wearing of a wristband or anti-static gloves when handling this product.
 - All devices, equipment and machinery must be properly grounded. It is recommended that precautions be taken against surge voltage to the equipment that mounts the LEDs.
 - ESD sensitivity of this product is 1000V (HBM, based on JEITA ED-4701/304).
 - When inspecting the final products in which LEDs were assembled, it is recommended to check whether the assembled LEDs are damaged by static electricity or not.
 - It is easy to find static-damaged LEDs by a light-on test.

Symbol	CITILED
Name	CL-L330-MC26L1-C
CITIZEN ELECTRONICS CO.,LTD. JAPAN	

8. Precautions (continued)

7. Lighting at a low current

A minimum current value of lighting of all dice is 60mA.

When a minimal current is applied, LED dice may look different in their brightness due to the individual difference of the LED element, and it is not a failed product.

8. Please be aware that this product should not come into contact with any other parts in assembled status.

9. Drive circuit

- A constant current circuit is recommended as a drive circuit.
And when two or more LED packages are connected, the series connection between each package is recommended.
- Please design a circuit that prevents any reverse voltage (excess current) from being applied to this product instantaneously when the circuit is ON or OFF.

10. Heat generation

- As this product is designed with consideration of the heat release property of module, a heat release design is required to use this product efficiently.
Please ensure that heat generation is not in excess of the absolute maximum rating. (Refer to 4-1 Performance)
- Factors responsible for an increase in temperature include heat generation attributed to ambient temperature conditions or power dissipation. Thus, drive conditions should be taken into consideration, depending on ambient temperature (Ta).

11. Recommended soldering condition

- Manual soldering
- Soldering shall be implemented using a soldering bit of 40W or less with a temperature 350°C or less within 3.5 seconds for one land.
(Recommended condition in a case of lead-free solder condition)
- No external force shall be applied to resin part during soldering.
- Next process of soldering should be carried out after the product has returned to ambient
- For soldering correction
- Regarding soldering correction, above conditions shall be used.
- Contacts number of soldering bit should be within twice for each terminal as a correction.

* Citizen Electronics cannot guarantee if usage exceeds this recommended conditions. Please use it after sufficient verification is carried out on your own risk if necessary.

12. Other

- This product complies with RoHS directives.

Symbol	CITILED
Name	CL-L330-MC26L1-C
CITIZEN ELECTRONICS CO.,LTD. JAPAN	

9. Precautions with regard to product use

1. This document is provided for reference purposes only so that CITIZEN ELECTRONICS' products are used as intended. CITIZEN ELECTRONICS neither makes warranties or representations with respect to the accuracy or completeness of the information contained in this document nor grants any license to any intellectual property rights or any other rights of CITIZEN ELECTRONICS or any third party with respect to the information in this document.
2. All information included in this document such as product data, diagrams, charts, is current as of the date this document is issued.
Such information, however, is subject to change without any prior notice.
Before purchasing or using any CITIZEN ELECTRONICS' products listed in this document, please confirm the latest product information with a CITIZEN ELECTRONICS' sales office, and formal specifications must be exchanged and signed by both parties prior to mass production.
3. CITIZEN ELECTRONICS has used reasonable care in compiling the information included in this document, but CITIZEN ELECTRONICS assumes no liability whatsoever for any damages incurred as a result of errors or omissions in the information included in this document.
4. Absent a written signed agreement, except as provided in the relevant terms and conditions of sale for product, and to the maximum extent allowable by law, CITIZEN ELECTRONICS assumes no liability whatsoever, including without limitation, indirect, consequential, special, or incidental damages or loss, including without limitation, loss of profits, loss of opportunities, business interruption and loss of data, and disclaims any and all express or implied warranties and conditions related to sale, use of product, or information, including warranties or conditions of merchantability, fitness for a particular purpose, accuracy of information, or no infringement.
5. Though CITIZEN ELECTRONICS works continually to improve products' quality and reliability, products can malfunction or fail. Customers are responsible for complying with safety standards and for providing adequate designs and safeguards to minimize risk and avoid situations in which a malfunction or failure of a product could cause loss of human life, bodily injury or damage to property, including data loss or corruption.
In addition, customers are also responsible for determining the appropriateness of use of any information contained in this document such as application cases not only with evaluating by their own but also by the entire system.
CITIZEN ELECTRONICS assumes no liability for customers' product design or applications.
6. Please contact CITIZEN ELECTRONICS' sales office if you have any questions regarding the information contained in this document, or if you have any other inquiries.

Symbol	CITILED
Name	CL-L330-MC26L1-C
CITIZEN ELECTRONICS CO.,LTD. JAPAN	