

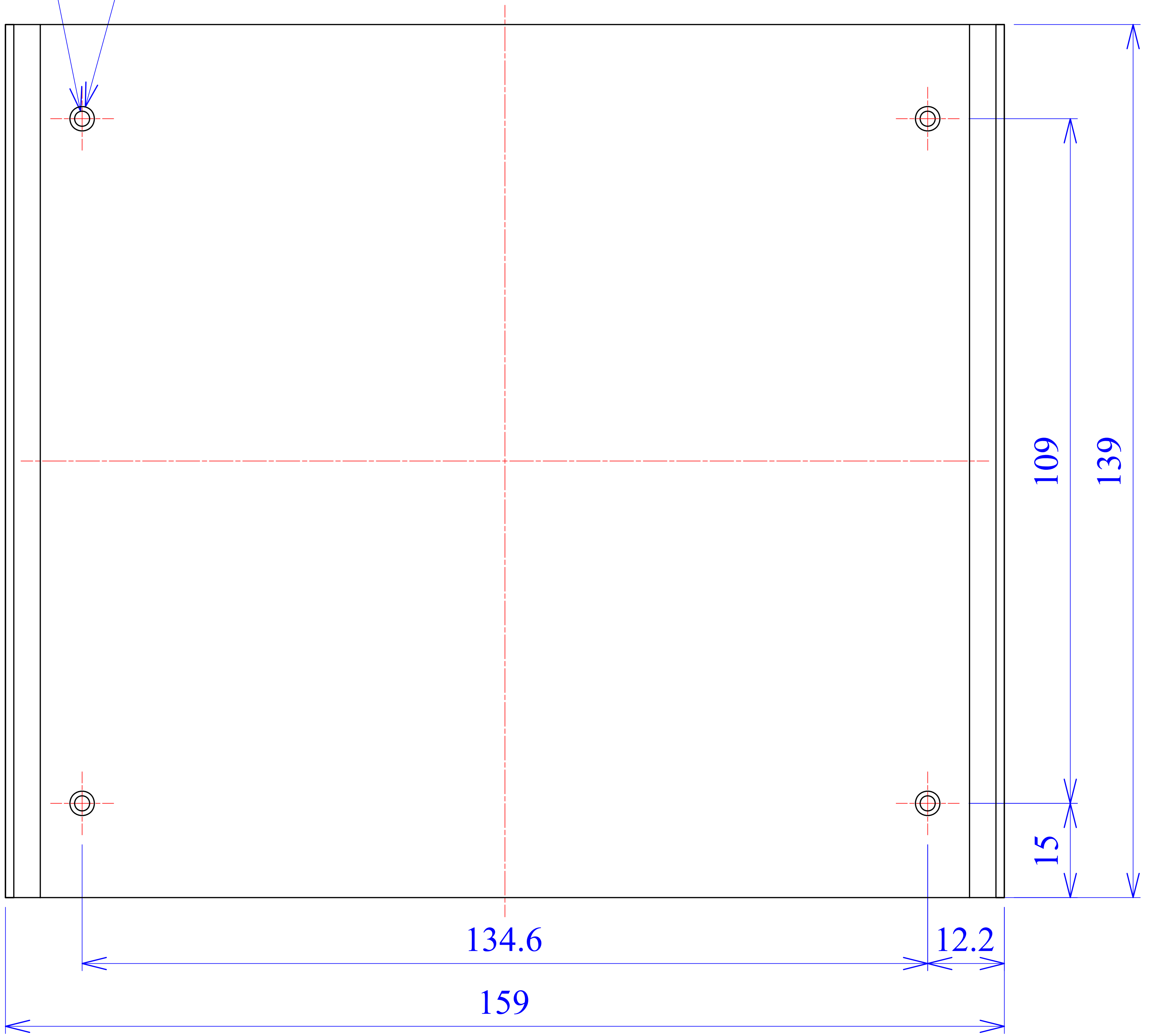

4x Ø 2.4

4x Ø 3.9



C - C

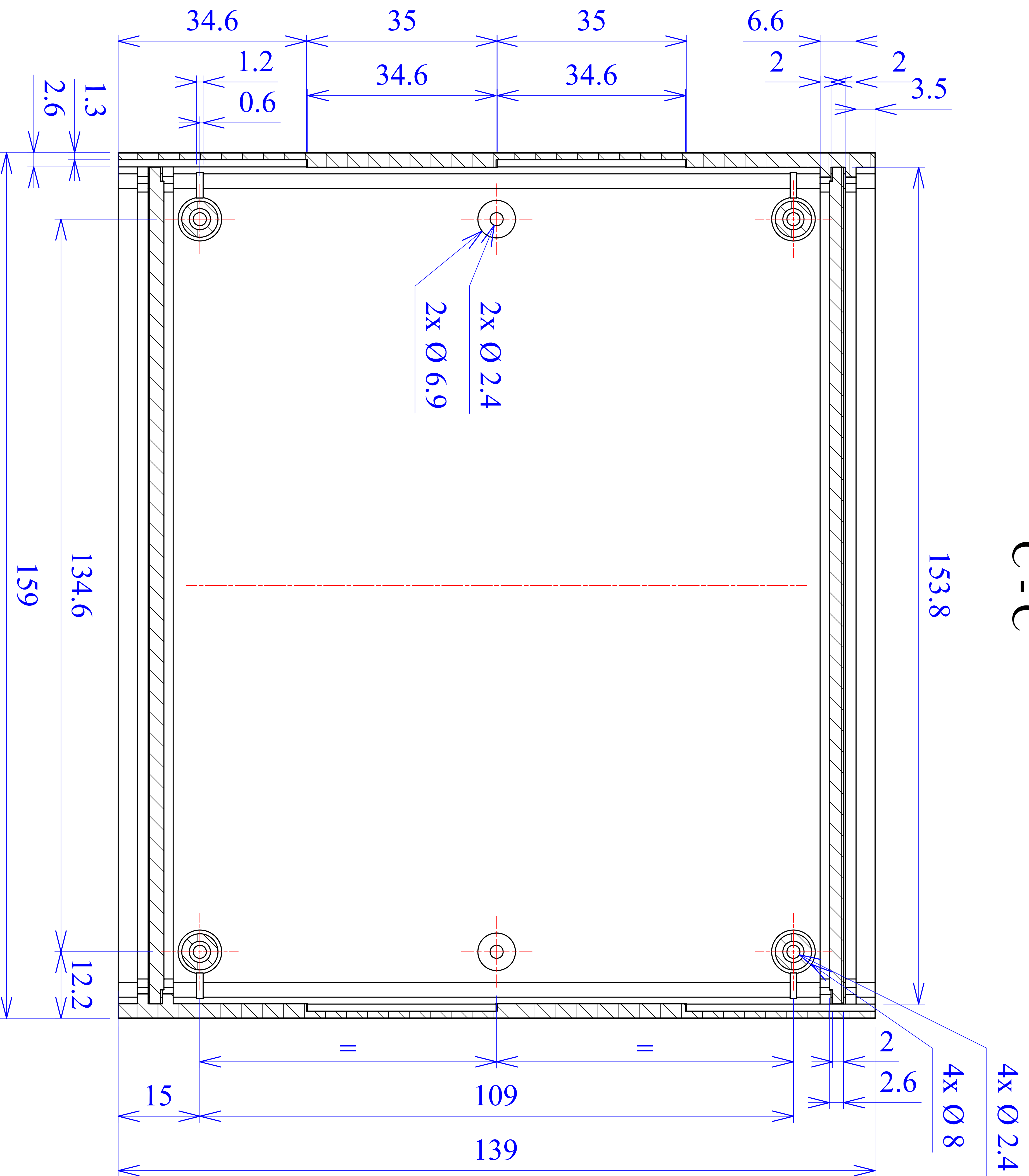

D - D

