

868MHz Multichannel Radio Modem

based on RadioControlli RCS1KSMT-868 device

The RCQ2-868 is a high performance wireless modem providing a reliable low cost serial data communications link that can be used for many data communications applications at an exceptionally competitive price. The modem operates in the ISM 868 MHz band. The RF modem is very simple to use and provides a wireless RS232 link with a RF data rate of up to 100 kbps. The transceivers have the functions of a complete radio modem and simply require CMOS/TTL data at the transmit input and the corresponding transceiver(s) output the same data. Preamble and CRC are automatically generated and added to the RF transmission.

The RCQ2-868 can use any channel in 100 (200) KHz step. Possible applications include one-to-one and multi-node wireless links in applications including security, EPOS, wireless sensor network, industrial process monitoring and computer networking. Because of their small size and low power requirements, (the consumption in power down mode is $< 2\mu\text{A}$) this module is a ideal for use in portable, battery-powered applications such as hand-held terminals.



RCQ2-868

Applications :

- Wireless security systems
- Home and building automation
- Automatic Measure Reading
- Industrial Control and Monitoring
- Wireless Sensor Network
- EPOS Terminal

Feature :

- Radio Modems Application Inside
- RF Power until +20dBm (100mW)
- Low consumption technology
- RF Data Rate to 100Kbps
- RF Channel Selectable
- Serial Data Interface with Handshake
- Host Data Rate up to 38400 Baud
- Very Stable Operating Frequency

Operating Mode :

- One to One
- One to Many
- Broadcast
- Many to One

1.0 Pin Out and Mechanical dimensions

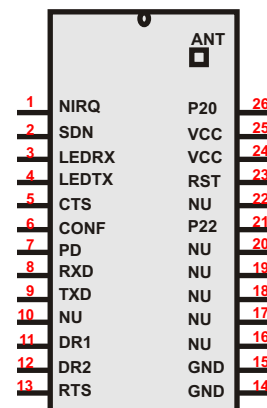
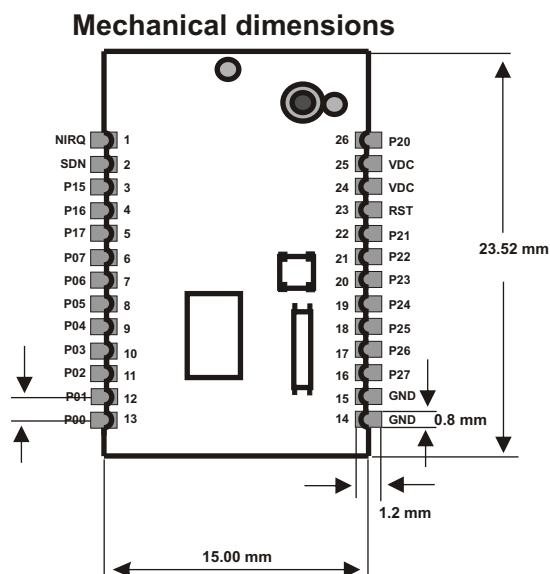

Pin Out Description

Pads	Name	Type	Description
1	NIRQ	Output	In this application this pin must be connected to pin 21 with a pull-up resistor
2	SDN	Input	In this application this pin must be connected to pin 26 and insert a pull-down resistor
3	LED_TX	Input/Output	LED TX(open collector input/output max 4mA)
4	LED_RX	Input/Output	LED RX(open collector input/output max 4mA)
5	CTS	Output UART	UART Clear to Send
6	CONF	InputL	Configuration Modality
7	PD	Input	Power Down Mode
8	RXD	Output UART	Uart TX
9	TXD	Input UART	Uart RX
10	N.U.	N.U.	Not Used
11	DR1	Input D I/O	DR1 Baude rate selection
12	DR2	Input D I/O	DR2 Baude rate selection
13	RTS	Input UART	UART Request to Send
14	GND	Ground	Ground
15	GND	Ground	Ground
16	N.U.	N.U.	Not Used
17	N.U.	N.U.	Not Used
18	N.U.	N.U.	Not Used
19	N.U.	N.U.	Not Used
20	N.U.	N.U.	Not Used
21	P22	Input	In this application connected to pin 1
22	N.U.	N.U.	Not Used
23	RST	Input	Device Reset
24	VCC	Power	Power supply voltage
25	VCC	Power	Power supply voltage
26	P20	CONTROL	In this application connected to pin 2

Data Rate Selection

SERIAL PORT SETUP : 1 START, 8 BIT, 1 STOP, NO PARITY

DR1 (pin12)	DR2 (pin13)	Baud Rate
GND	GND	4,800
GND	VCC	9,600
VCC	GND	19,200
VCC	VCC	38,400

(*) Is possible on request get up to 115200 baud rate
Every time you change the speed (baud rate) is necessary to RESET a device.

2.0 Technical Specifications

Technical Characteristics

Characteristics		MIN	TYP	MAX	UNIT
V _{cc}	Supply Voltage	2.2	3	3.6	VDC
I _s	Supply Current (RX mode)		20		MA
I _s	Supply Current (TX mode / +20dBm)		85		mA
I _s	Supply Current (TX mode / 0 dBm)		10		mA
I _s	Supply Current sleep mode		< 2		µA
T ₁	Power up to stable receiver data out		30		mS
T ₂	Power up to full RF Power out		30		mS
T ₃	Standby to Receive mode		1		mS
T ₄	Standby to Transmit mode		1		mS
F	RX Frequency Range CEPT/ERC/REC 70-03	868		870	MHz
P _o	RF Output Power	1		+20	dBm
S	RF Sensitivity (1.2 Kb/sec Data Rate)		-121		dBm
D	Frequency Deviation		+ - 50		KHz
M	GFSK Manchester encoded data rate		100		Kbps
T _{OP}	Operating Temperature Range	-10		+55	°C

3.0 Application

The RCQ2-868 Radio Modem has applications in many areas where reliable half duplex communications are required over ranges up to 200 meters (with the maximum RF Power is possible to reach up to 400-500meters).

The crystal controlled narrow band design, in the embedded RCQ2-868 device, gives reliable performance within the 868 MHz band.

The addressing protocol employed enables many different configurations such including:

one-to-one operation: for point to point data communication;

broadcast operation: where a single master address many RCQ2-868 modules concurrently (using many RCQ2-868 modules set to the same address);

one-to-many: a network consisting a master and many slaves (the receivers all have the same address)

many-to-one: where the transmitters all send to a single receiver address

Since each RCQ2-868 can contain a unique address, multiple RCQ2-868 network can co-exist in the same area.

4.0 Operation Mode

The Data Rate pins (11,12) are read when the RESET is performed (pin 23).

The RCQ2-868 must be put into standby mode by taking the PD pin low (pin 7 = GND) to change the Baud Rate selection.

The size of RF data packets are set in configuration mode.

If fewer bytes are received by the RCQ2-868 module than the preset size, then after 10ms from the last byte received from the host, the RF packet will be processed (expanded to meet the preset packet size) and transmitted. The RF data packet size must be set the same for transmitter and receiver, otherwise the received packets will be discarded.

In order to optimize data rate, in a point-to-point configuration where data is mostly being sent in one direction, the packet size for one data direction can be set to the maximum size, however the reverse direction may be set to a smaller packet size, to implement an acknowledge reply for example.

The RTS pin overrides the timeout value. If a short data packet is sent, RF transmission will start as soon as the RTS pin is taken 'high' after the last byte is sent to the module.

The RCQ2-868 contains an on-board data buffer equal to two data packets. Therefore if RTS is asserted (then the host is unable to receive data) the RCQ2-868 will store a max of two data bytes, all further data packets received will be discarded.

No RF packets will be received by the module when it is in power down mode.

Each RCQ2-868 has its own preset address. This is set during configuration. Any data received is examined and the address header, embedded within the data packet, is compared with the RCQ2-868 address. Only data received with matching address will be processed and output to the host, all other data will be discarded. All RCQ2-868 modules are shipped with a default address of 7E7E7E7E.

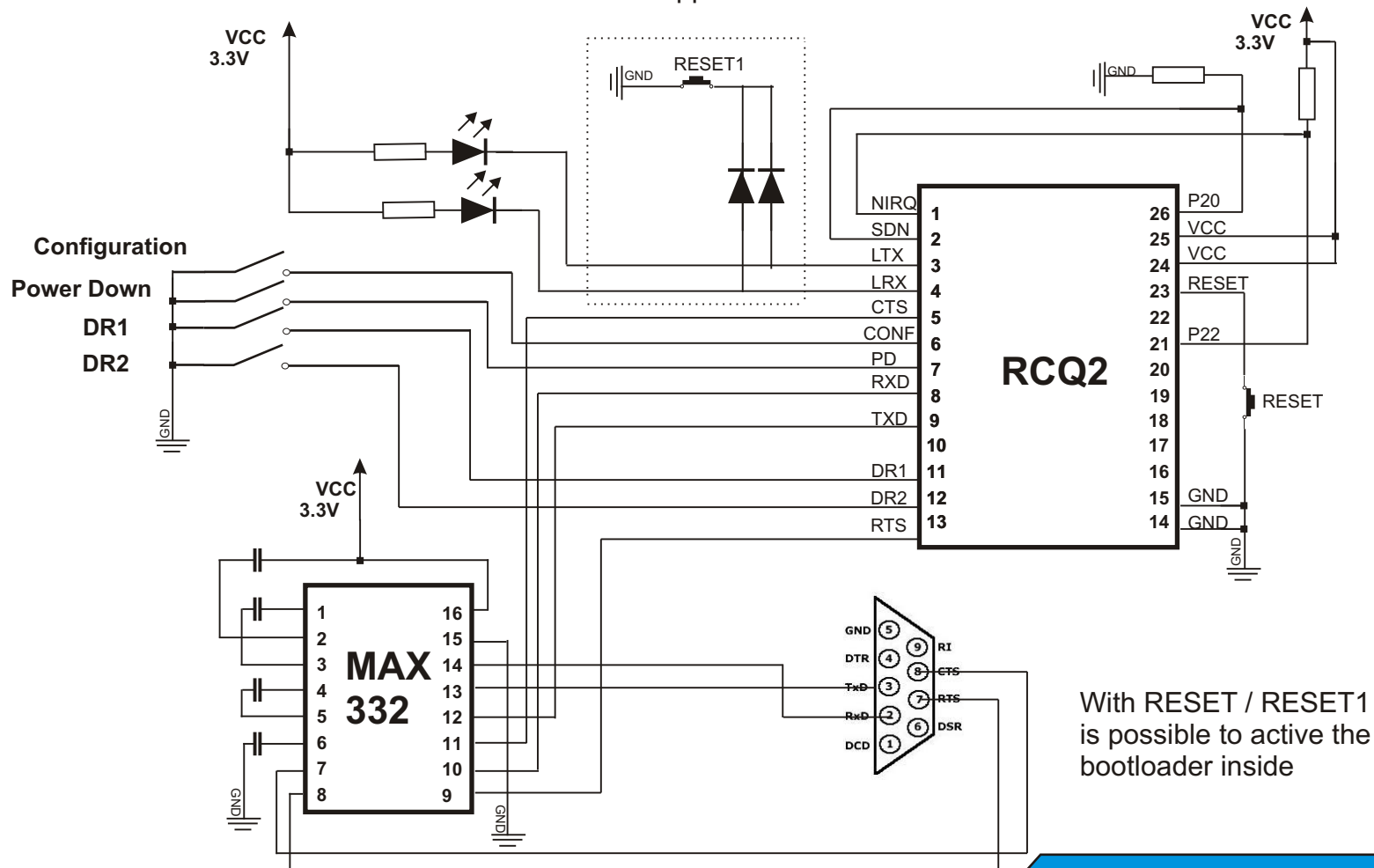

With RESET / RESET1 is possible to active the bootloader inside

5.0 Configuration Mode

Byte	Name	Description	Default Value (HEX)
0		MSB	7E
1	Destination Address		7E
2			7E
3		LSB	7E
4		MSB	7E
5	RCQ2-868 Address		7E
6			7E
7		LSB	7E
8	RF CHANNELS	75 = (868.2MHz)	75 = (868.2MHz)
		76 = (868.4 MHz)	
		77 = (868.6 MHz)	
		78 = (868.8 MHz)	
		79 = (869.0 MHz)	
		7A = (869.2 MHz)	
		7B = (869.4 MHz)	
		7C = (869.6 MHz)	
		7D = (869.8 MHz)	
		7E = (870.0 MHz)	
9	RF TX POWER	00 = 1 dBm (1.25mW)	00 = 1 dBm
		01 = 2 dBm (1.58mW)	
		02 = 5 dBm (3.16mW)	
		03 = 8 dBm (6.3mW)	
		04 = 11 dBm (12.5mW)	
		05 = 14 dBm (25mW)	
		06 = 17dBm (50mW)	
		07 = 20dBm (100mW)	
10	TX DATA PACKET SIZE		1E (30 bytes)
11	RX DATA PACKET SIZE		1E (30 bytes)

The RF Channel is calculated in this mode:

868 MHz working frequency : Configuration value (decimal) = [(desired RF frequency / 2) - 422.4MHz] * 10

The Configuration pin (Pin 6) must be low (ground) to set up the RCQ2-868 module.

If the Configuration pin is still low at the end of the configuration then the module will send the current configuration back to the host.

To retrieve the current configuration without changing any options the host can send a single byte to the module and wait for the response.

The RCQ2 module will accept a short configuration after a 10ms timeout after the last byte sent to the module, or when the RTS pin goes high.

This allows for the host to easily change the destination address of the RF data packet, thus enabling one RCQ2-868 to send individual data to several different recipient modules.

RF data packets received by the RCQ2-868 with the embedded destination address which matches the RCQ2-868 address will be accepted, processed and passed to the host, all of the RF data packets will be ignored. When configuring the destination or RCQ2-868 address an incorrect number of bytes for an address will leave the current address unchanged. An invalid Transmitter Power or Packet Size setting will leave the current setting unchanged.

WARNING

RF Channel frequency for default is fixed at 868.2MHz (parameter=75) .

RCQ2-868 max power is 20dBm (100mW)

It is recommended use this device in accordance with the CEP/ERC REC 70-03 (below band plan).

CEPT / ERC Rec 70-03 (869 MHz BAND PLAN)

Application	SRD	Alarms	SRD	Social	Alarms	SRD	SRD	Alarms	SRD
Channel Spacing	No spacing	25KHz	No spacing	25KHz	25KHz	25KHz	25KHz	25KHz	No spacing
Duty Cycle	< 1%	<0.1%	< 1%	<0.1%	No limit	< 10%	< 10%	< 10%	Up to 100%

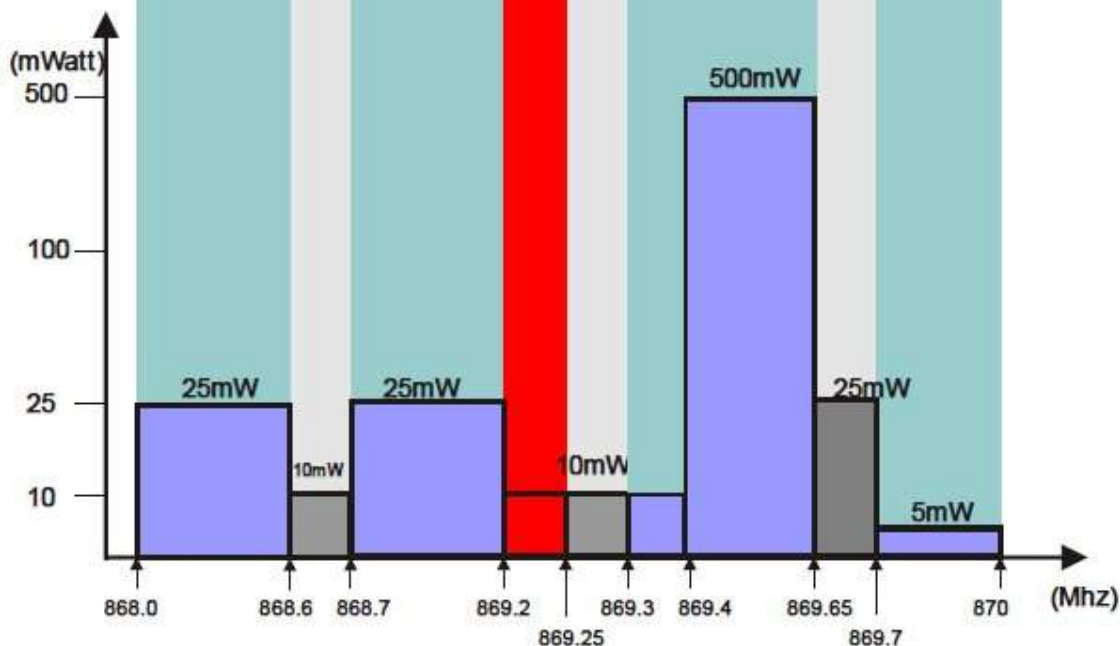

6.0 Example of Configuration

The Configuration pin (Pin 6 must be low (ground) to enter into configuration mode.

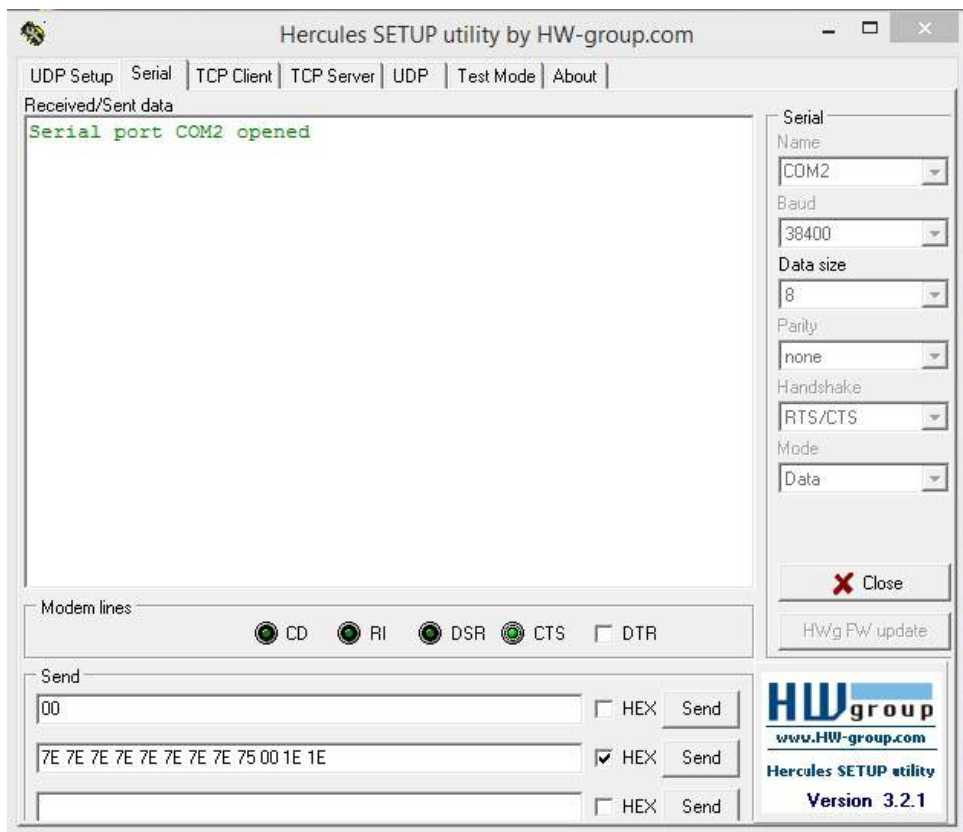

Software used : Hercules SETUP utility (free use)

Open the serial port with this parameters

Set the Hercules software to receive hexadecimal character (press the right mouse button).

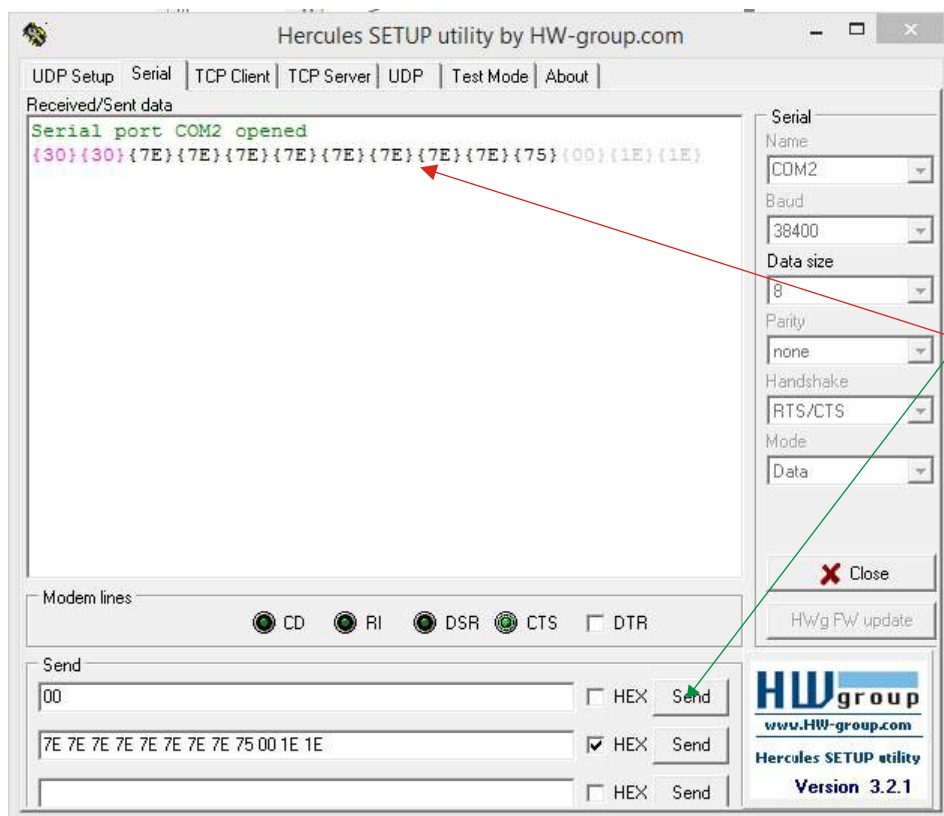

We hold this button, in this mode we sent "00" only 2 character

The module answer sent your configuration default parameters: 7E 7E 7E 7E 7E 7E 7E 7E 75 00 1E 1E

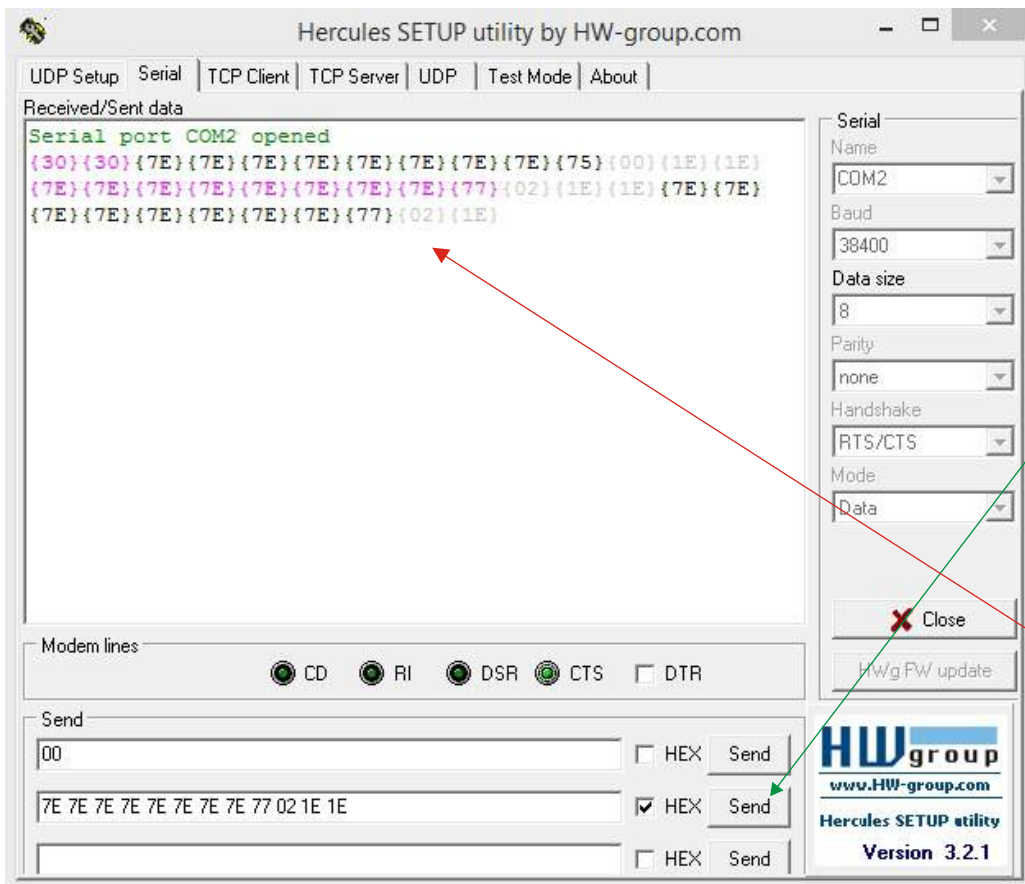

We hold this button, in this mode we sent the new Configuration String 7E 7E 7E 7E 7E 7E 7E 7E 77 02 1E 1E (hexadecimal string)
We have changed the parameters in red :

77 Frequency = 868.6MHz

02 RF Power Output = 5dBm

The module answer confirming the new configuration :
7E 7E 7E 7E 7E 7E 7E 7E 7E 7E 77 02 1E 1E

Set the Configuration pin (Pin 6) to HIGH for operation mode.

7.0 Example of Operation Mode (One to One)

This example is performed according to the following schematics and using the software Hercules SETUP utility (free use).

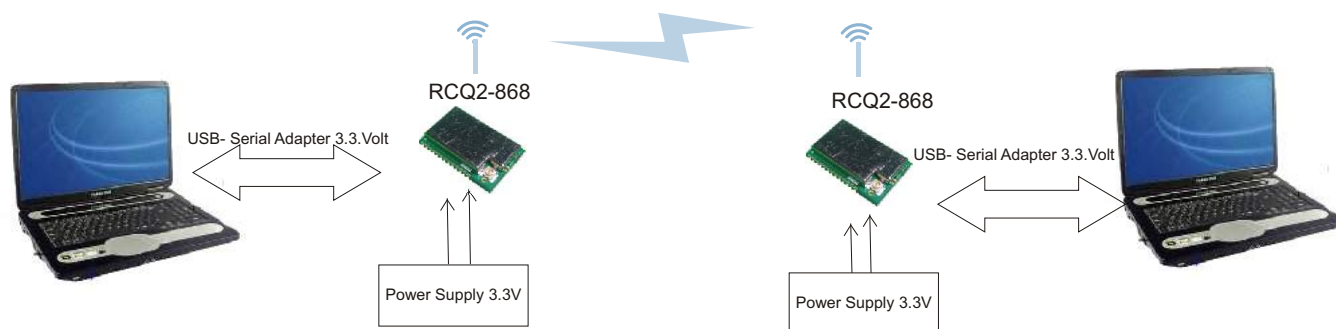

RADIO MODEM RCQ2-868



www.radiocontrolli.com

Personal Computer N.1 (COM2)

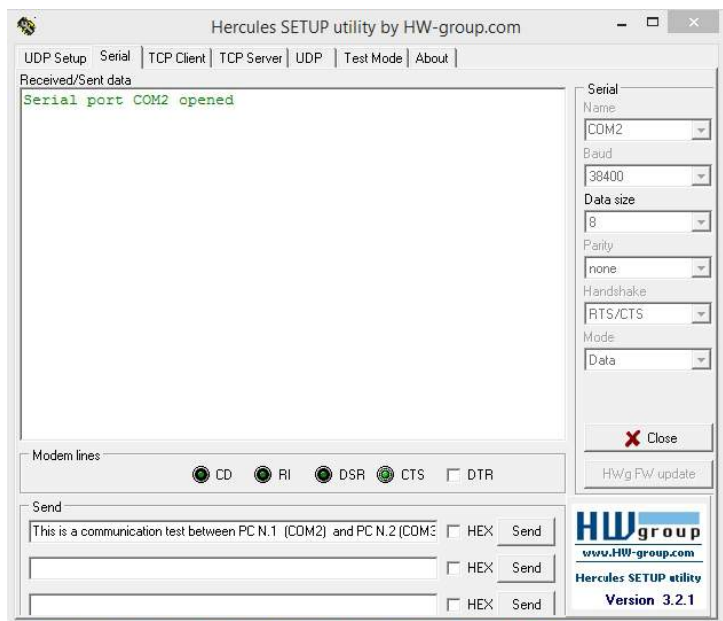

Personal Computer N.2 (COM3)

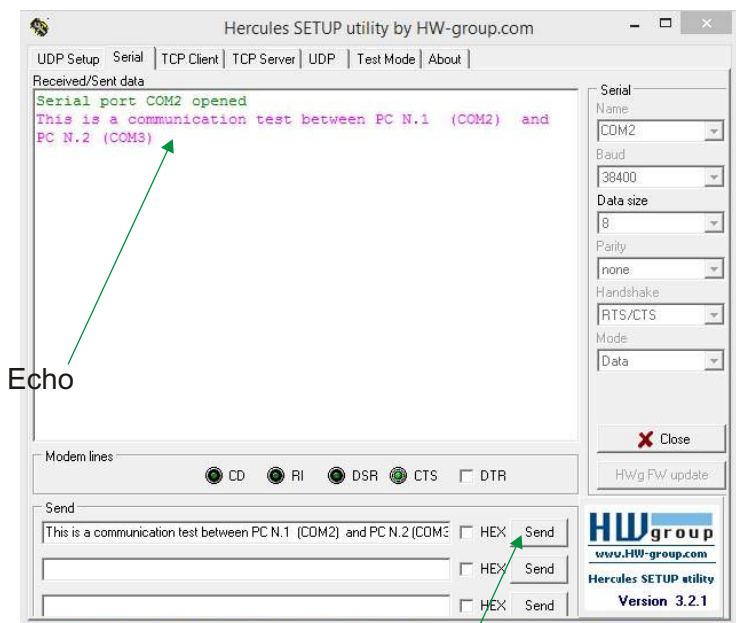
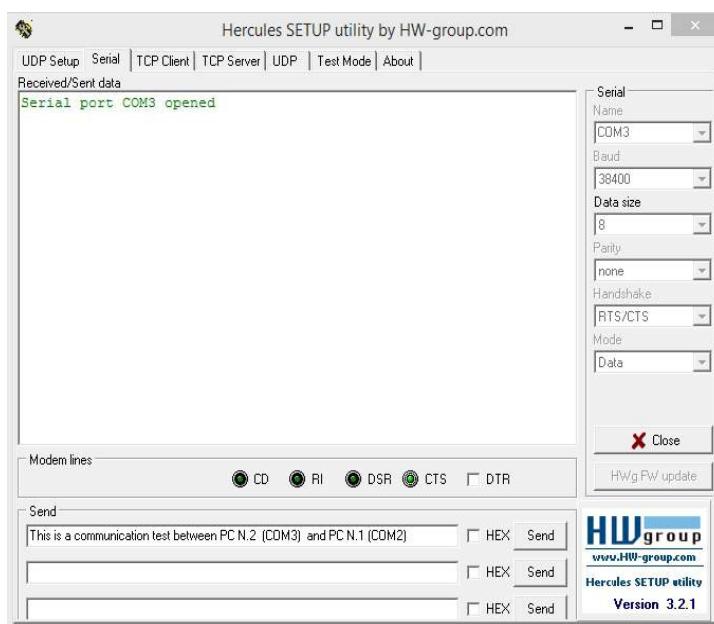

Echo

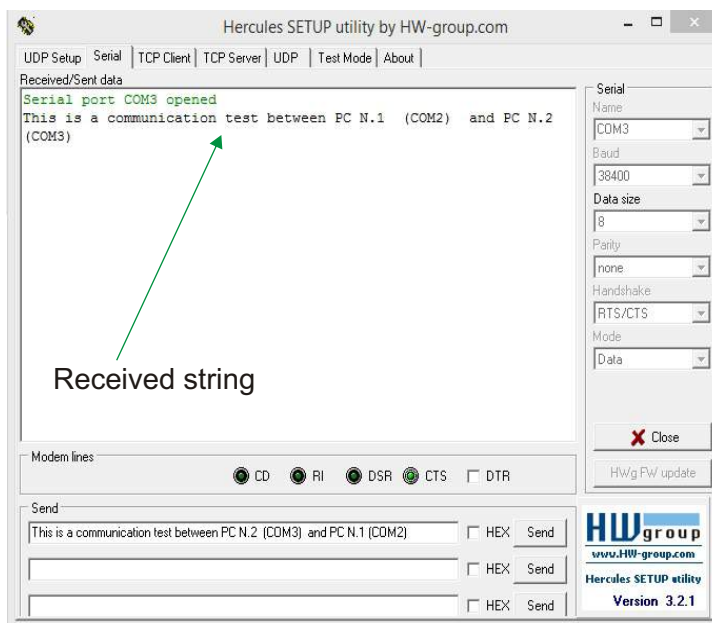

Received string

We hold this button, in this mode we sent the following string "This is a communication test between PC N.1 (COM2) and PC N.2 (COM3)"

Personal Computer N.1 (COM2)

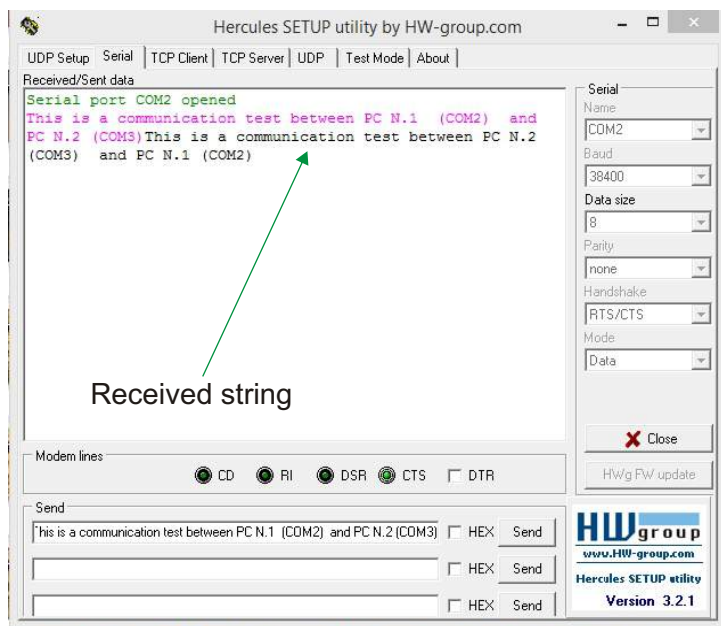

Personal Computer N.2 (COM3)

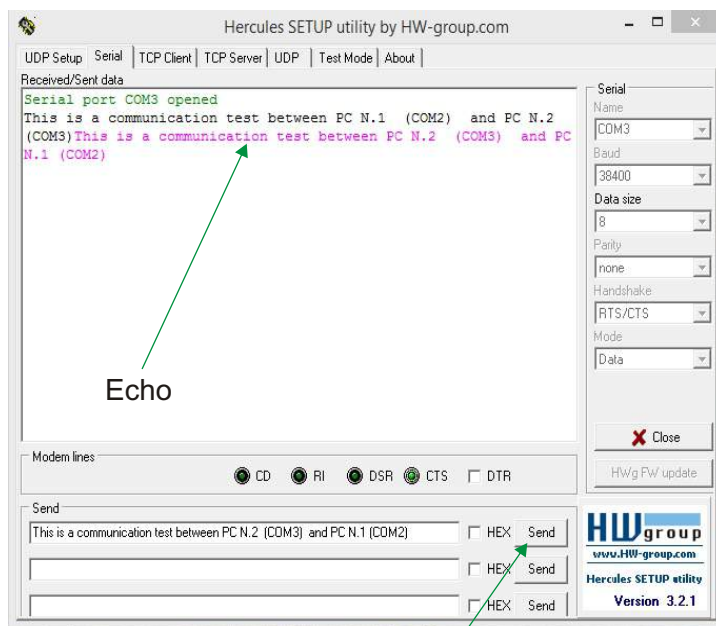

We hold this button, in this mode we sent the following string:

“This is a communication test between PC N.2 (COM3) and PC N.1 (COM2)”

8.0 Example of wireless transfer files (One to One)

This example is performed according to the following schematics and using the Hyperterminal software (free use).

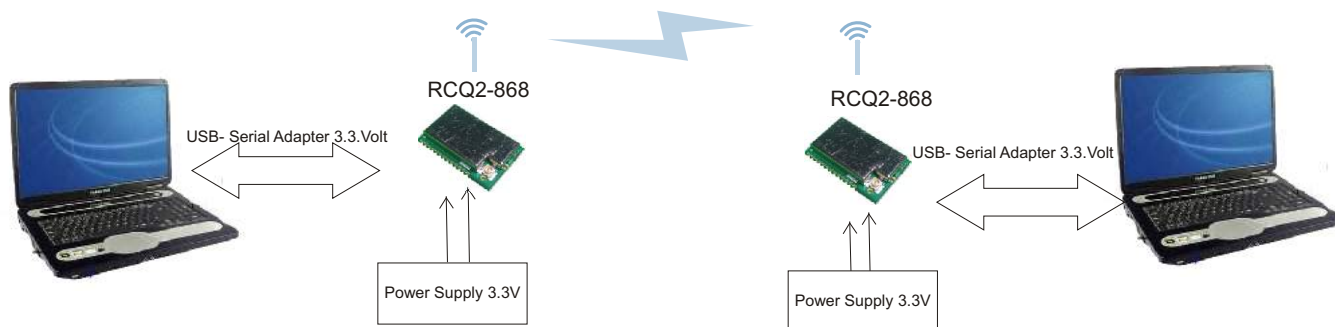

Personal Computer N.1

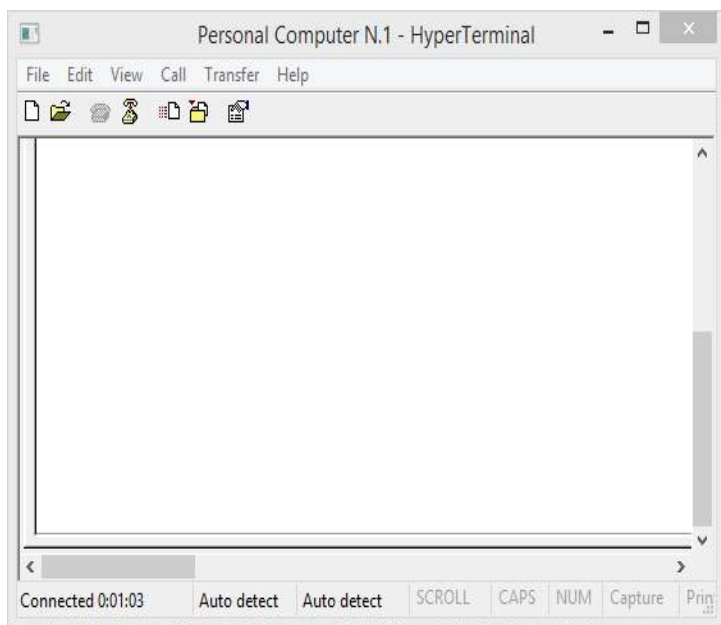

Personal Computer N.2

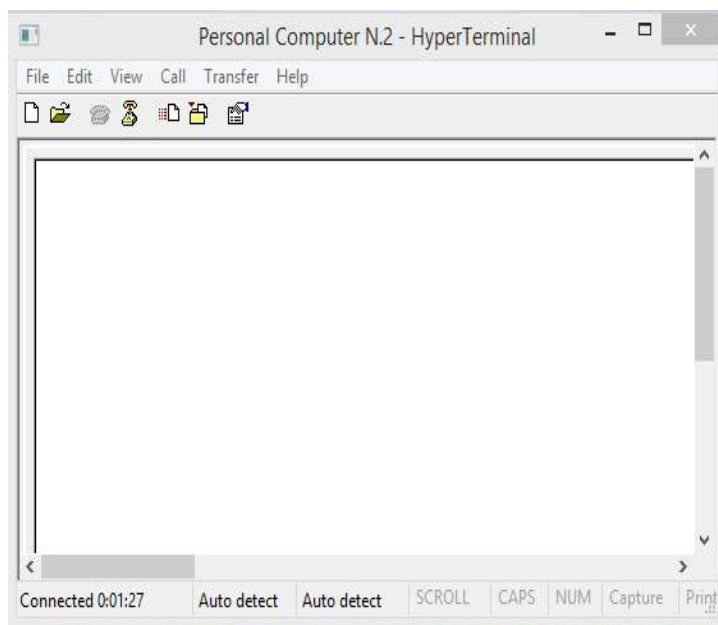

Serial Port Configuration = 38400, 8, N, 1, Hardware

Personal Computer N.2 - Receiver Setting

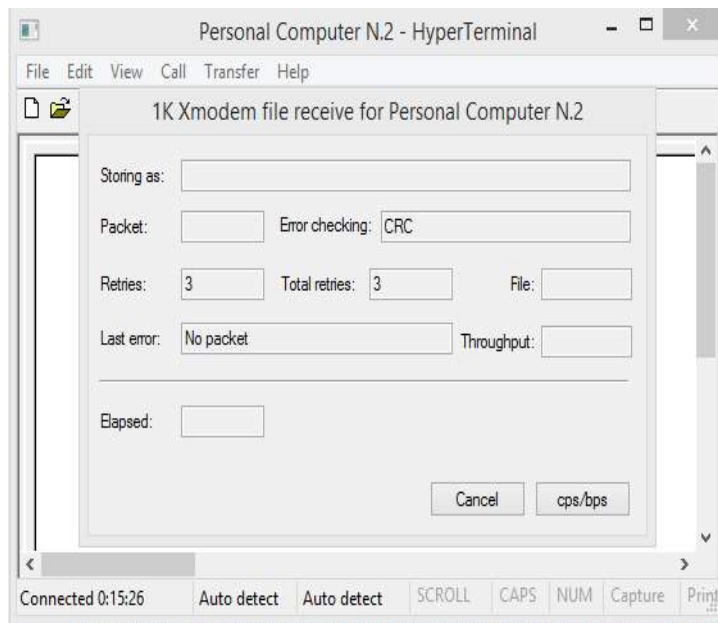
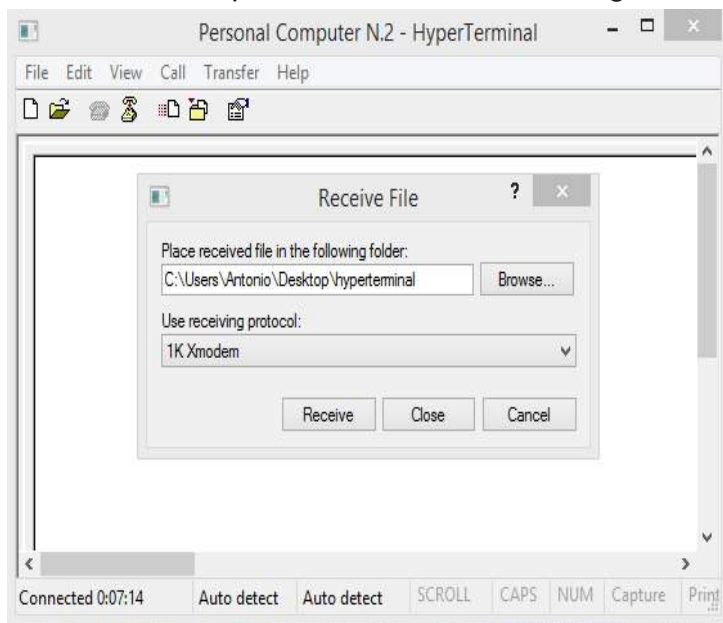

Menù Transfer ----> Receive Files -----> Select 1K Xmodem protocol

Press "Receive" button and insert file name.

The Personal Computer N.2 is ready to receive files from Personal Computer N.1

Personal Computer N.1 - Transmitter Setting

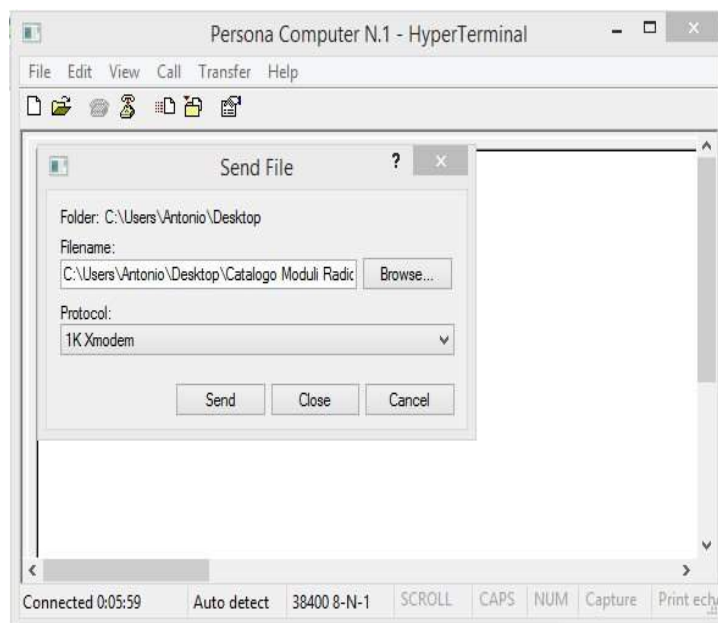
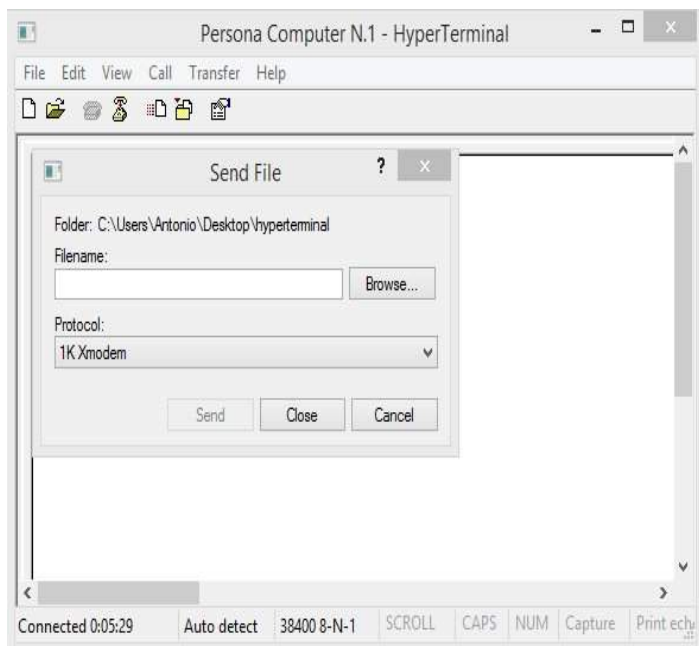

Menù Transfer ----> Send -----> Select 1K Xmodem protocol

Press "Send" button and choose the file to be transmitted.

In the picture below the Personal Computer N.1 is transmitting the file denominated : Catalogo Moduli Radio_1.pdf and the Personal Computer N.2 is receiving this file.

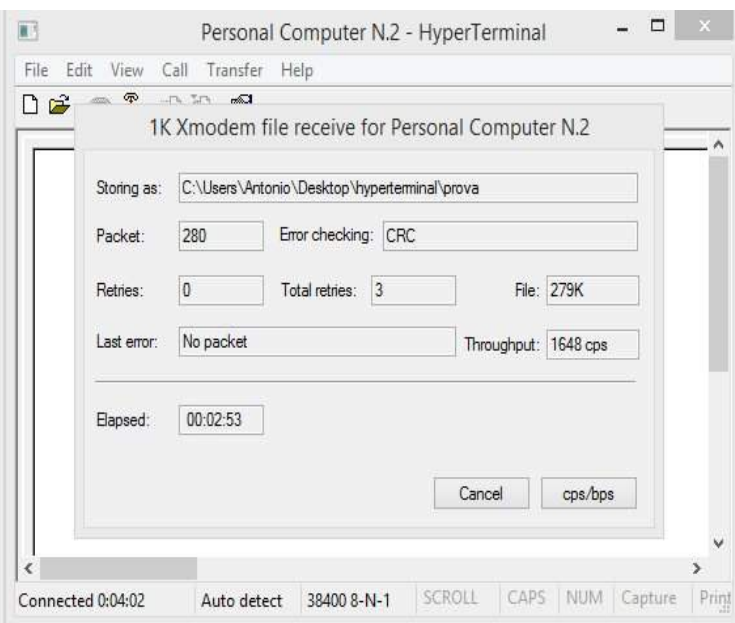
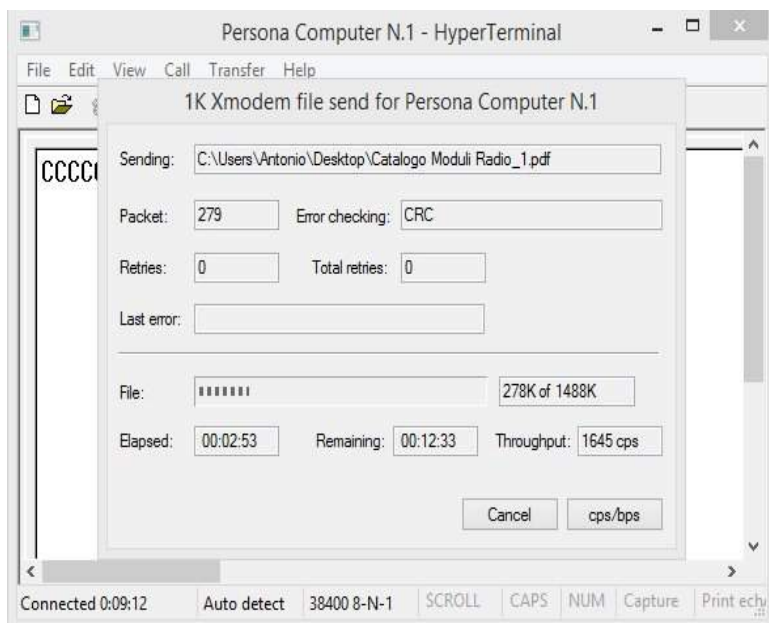

8.0 Antenna connection

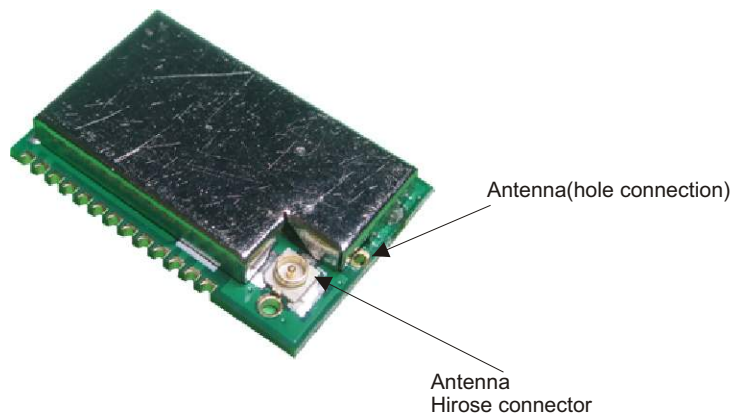

9.0 Evaluation board

Follow the description about the RCQ2-868 evaluation board.

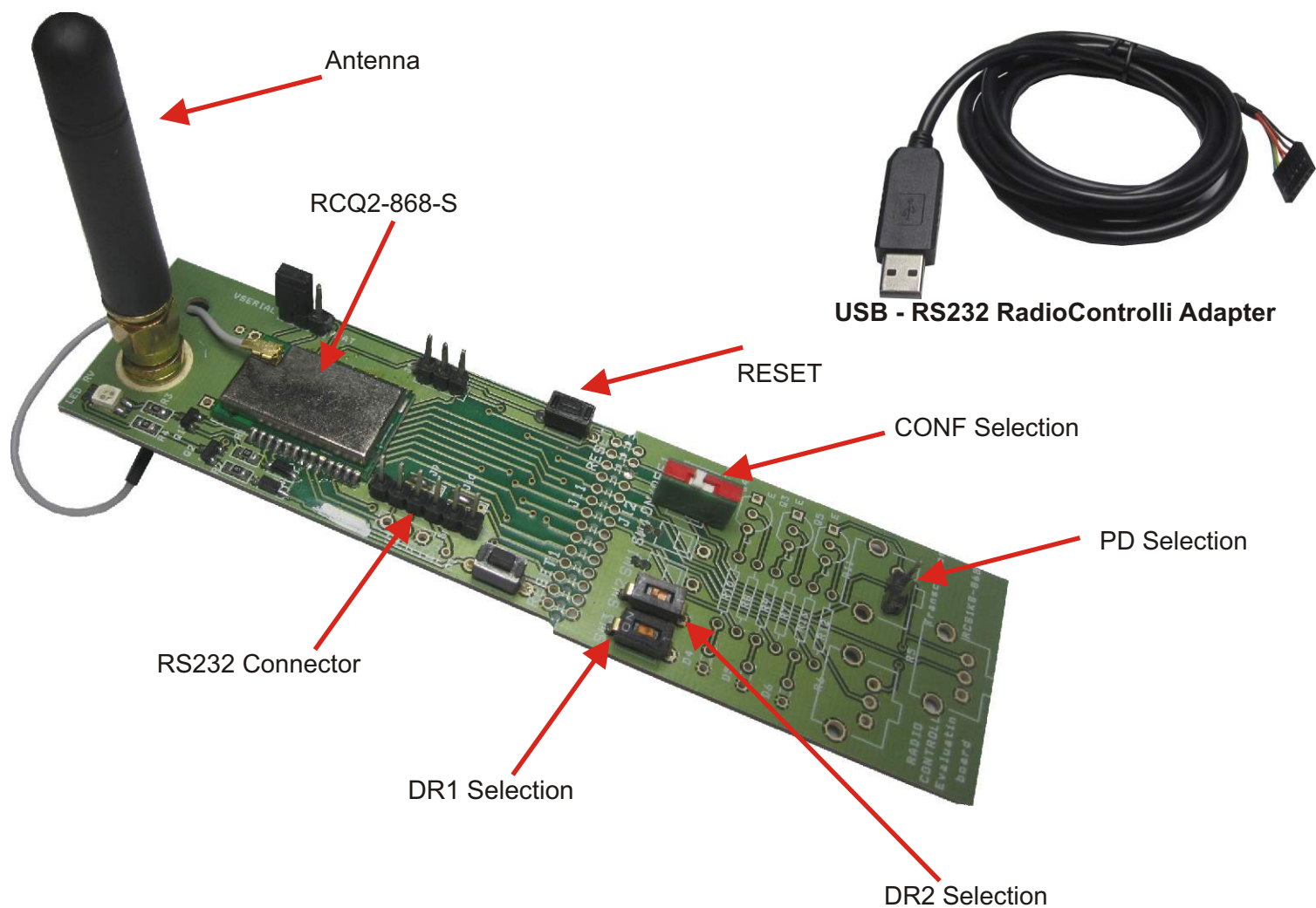

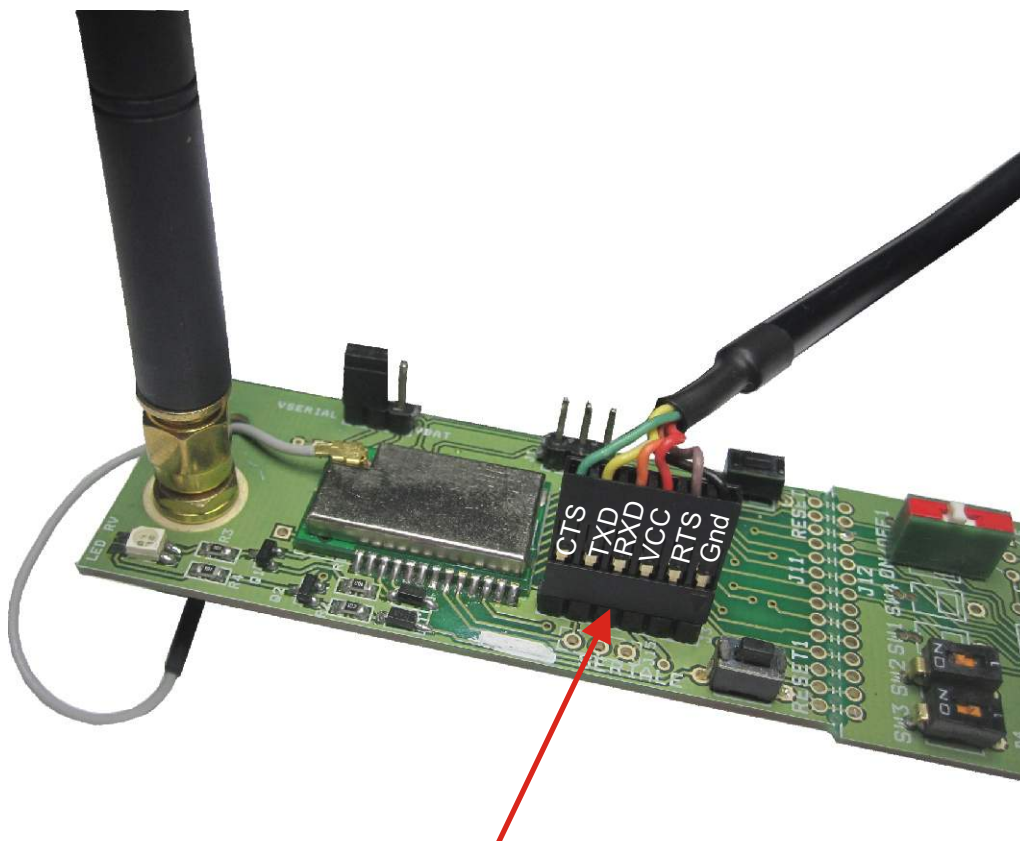

Insert the USB serial cable as shown in the picture above

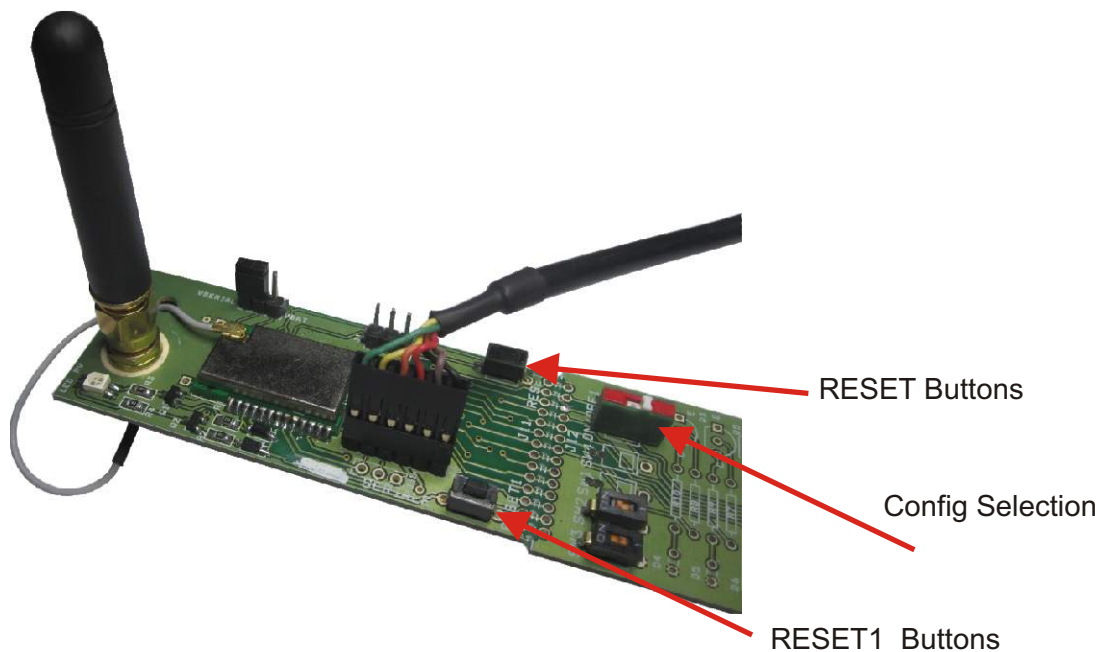

For default the baud rate is fixed at 38400 DR1/DR2 (high level).
Every time you change the speed (baud rate) is necessary to perform a RESET.
Move the dip switch showed in the picture above (CONF) to set the configuration of the device.