



DC COMPONENTS CO., LTD.

RECTIFIER SPECIALISTS

HER201
THRU
HER208

TECHNICAL SPECIFICATIONS OF HIGH EFFICIENCY RECTIFIER

VOLTAGE RANGE - 50 to 1000 Volts

CURRENT - 2.0 Amperes

FEATURES

- * Low power loss, high efficiency
- * Low leakage
- * Low forward voltage drop
- * High current capability
- * High speed switching
- * High surge capability
- * High reliability

MECHANICAL DATA

- * Case: Molded plastic
- * Epoxy: UL 94V-0 rate flame retardant
- * Lead: MIL-STD-202E, Method 208 guaranteed
- * Polarity: Color band denotes cathode end
- * Mounting position: Any
- * Weight: 0.4 gram



DO-15

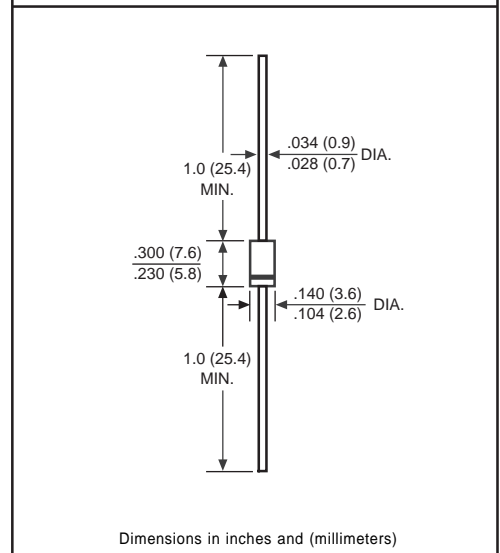

Dimensions in inches and (millimeters)

MAXIMUM RATINGS AND ELECTRICAL CHARACTERISTICS

Ratings at 25 °C ambient temperature unless otherwise specified.
Single phase, half wave, 60 Hz, resistive or inductive load.
For capacitive load, derate current by 20%.

	SYMBOL	HER201	HER202	HER203	HER204	HER205	HER206	HER207	HER208	UNITS	
Maximum Recurrent Peak Reverse Voltage	V _{RRM}	50	100	200	300	400	600	800	1000	Volts	
Maximum RMS Voltage	V _{RMS}	35	70	140	210	280	420	560	700	Volts	
Maximum DC Blocking Voltage	V _{DC}	50	100	200	300	400	600	800	1000	Volts	
Maximum Average Forward Rectified Current at T _A = 50°C	I _O	2.0								Amps	
Peak Forward Surge Current 8.3 ms single half sine-wave superimposed on rated load (JEDEC Method)	I _{FSM}	50								Amps	
Maximum Instantaneous Forward Voltage at 2.0A DC	V _F	1.0			1.3		1.7			Volts	
Maximum DC Reverse Current at Rated DC Blocking Voltage T _A = 25°C	I _R	5.0								uAmps	
Maximum Full Load Reverse Current Average, Full Cycle .375*(9.5mm) lead length at T _L = 55°C		100								uAmps	
Maximum Reverse Recovery Time (Note 1)	t _{rr}	50			75		100			nSec	
Typical Junction Capacitance (Note 2)	C _J	30					20				pF
Operating and Storage Temperature Range	T _J , T _{STG}	-65 to + 150									°C

NOTES : 1. Test Conditions: I_F = 0.5A, I_R = 1.0A, I_{RR} = 0.25A
2. Measured at 1 MHz and applied reverse voltage of 4.0 volts

RATING AND CHARACTERISTIC CURVES (HER201 THRU HER208)

FIG.1- TEST CIRCUIT DIAGRAM AND REVERSE RECOVERY TIME CHARACTERISTIC

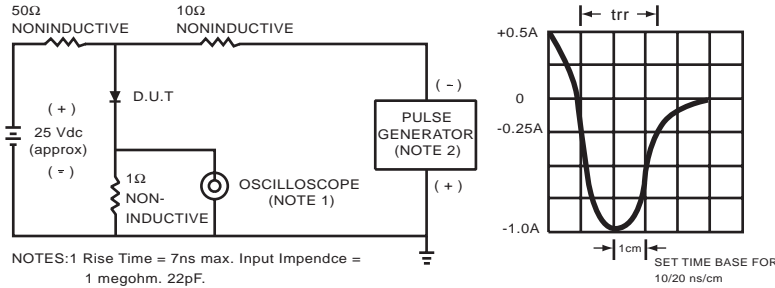

NOTES:1 Rise Time = 7ns max. Input Impedance = 1 megohm. 22pF.
2 Rise Time = 10ns max. Source Impedance = 50 ohms.

FIG.2- TYPICAL FORWARD CURRENT DERATING CURVE

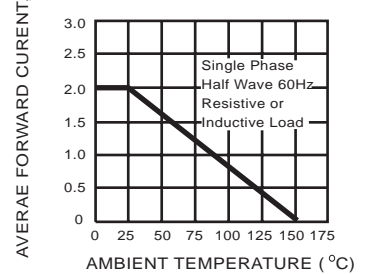

FIG.3- TYPICAL REVERSE CHARACTERISTICS

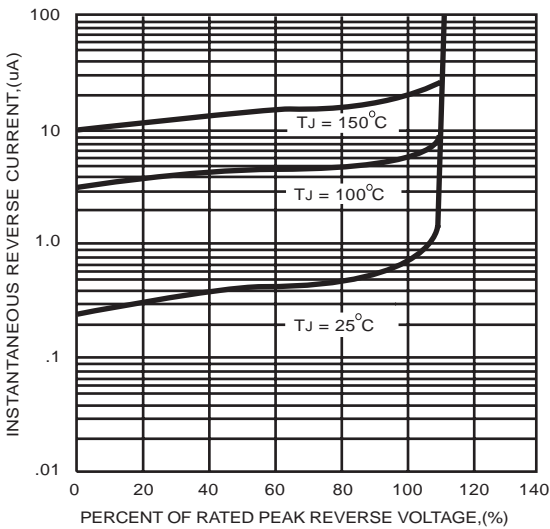

FIG.4- TYPICAL INSTANTANEOUS FORWARD CHARACTERISTICS

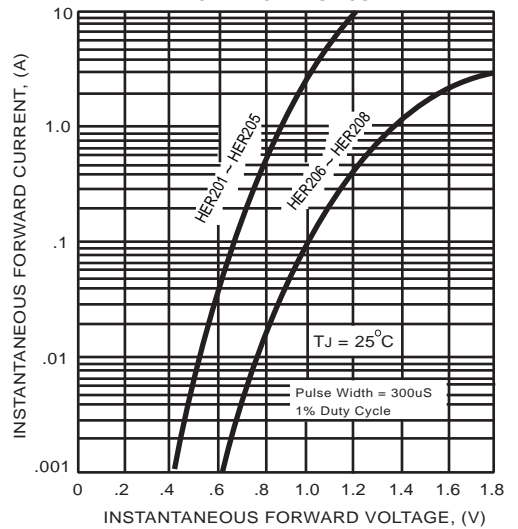

FIG.5- MAXIMUM NON-REPETITIVE FORWARD SURGE CURRENT

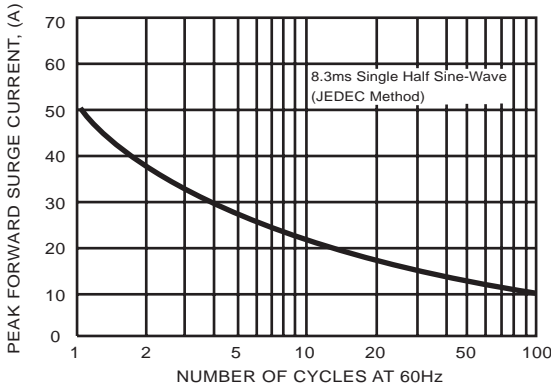
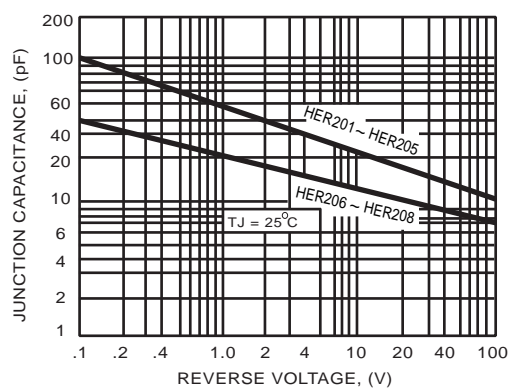

FIG.6- TYPICAL JUNCTION CAPACITANCE



DC COMPONENTS CO., LTD.