

GW-GSM-02A

IQRF GSM Gateway

User's Guide



Description

GW-GSM-02A is an IQRF gateway for connection between IQRF and GSM networks allowing remote monitoring, data collection and control of IQRF network.

Main components are: 8b microcontroller, GSM module with antenna, serial Flash memory and IQRF transceiver module with antenna.

The gateway can communicate outside the IQRF network via GPRS. Configuration is possible via IQRF IDE.

GW-GSM-02A allows communication with IQRF IDE to configure internal TR module and simply create IQRF networks. It is fully compatible with the DPA protocol. Non-DPA applications are supported as well.

GW-GSM-02A supports exchanging data with any cloud server designed according to IQRF Cloud server specification.



Applications

- Remote monitoring and control
- Data acquisition / collection
- Datalogger, IQRF Cloud supported
- Interface to building / home automation
- Connection of more IQRF networks to single PC
- DPA as well as non-DPA applications supported

Key features

- HTTP client for communication with IQRF Cloud server
- DHCP client for automated getting of IP address
- RTCC (real time clock/calendar)
- Firmware upgrade via IQRF IDE
- Upgrade of application in internal TR module via IQRF IDE
- DPA and IQRF IDE compatible

Block diagram

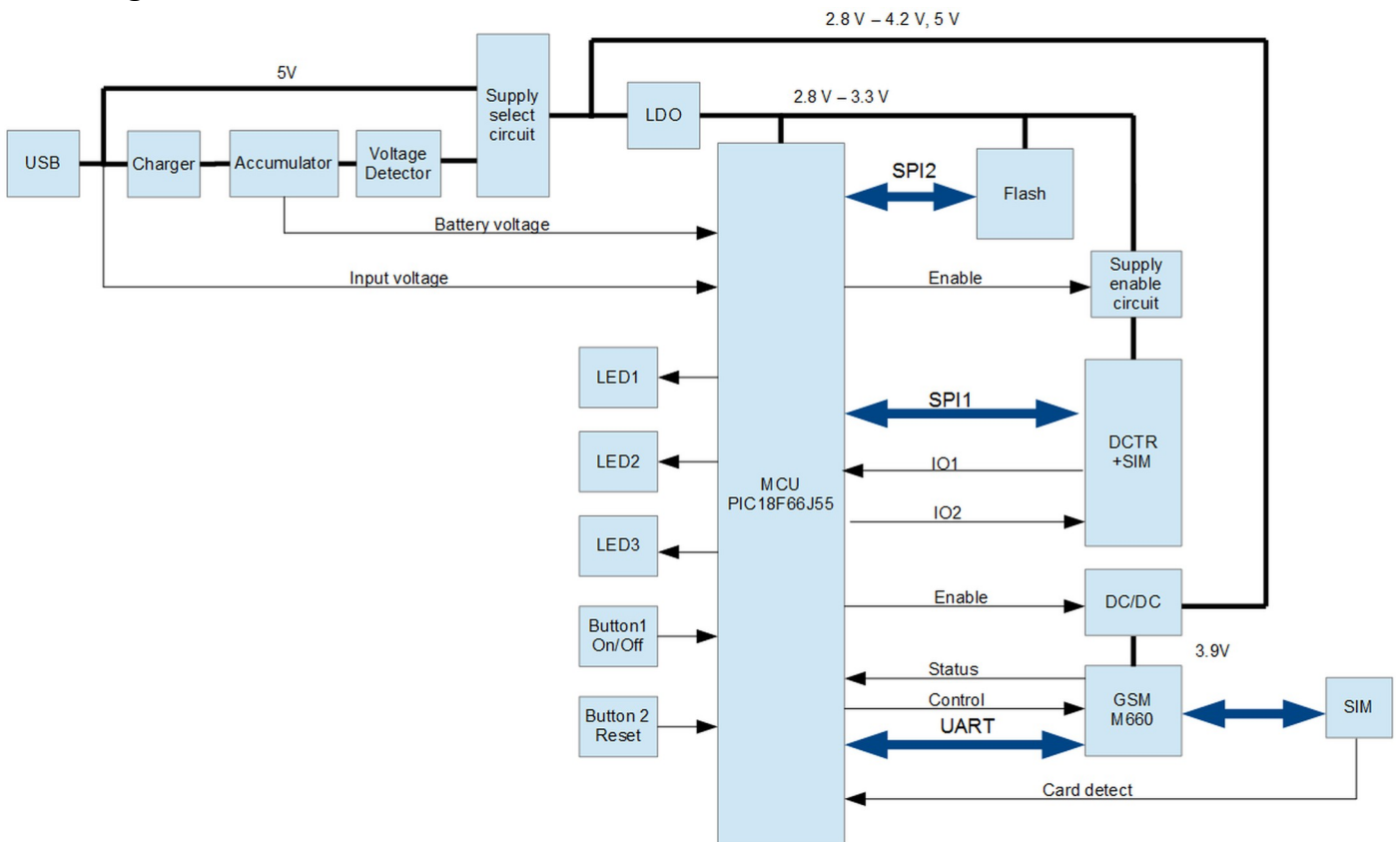

Information contained in this publication regarding device applications and the like is provided only for your convenience and may be superseded by updates. It is your responsibility to ensure that your application meets with your specifications.

IQRF Tech MAKES NO REPRESENTATIONS OR WARRANTIES OF ANY KIND TO STATED CONDITION, QUALITY, PERFORMANCE, MERCHANTABILITY OR FITNESS FOR PURPOSE and disclaims all liability arising from this information and its use. Use of IQRF Tech devices in life support and/or safety applications is entirely at the buyer's risk, and the buyer agrees to defend, indemnify and hold harmless IQRF Tech from any and all damages, claims, suits, or expenses resulting from such use. No licenses are conveyed, implicitly or otherwise, under any IQRF Tech intellectual property rights.

Electrical specifications*(Typical values unless otherwise stated)*

Power supply	4.8 V – 5.5 V DC
Accumulator	LI14500-1L, 3.7V, 700 mAh, soldered
Supply current	
Standby (all peripherals disabled, accumulator fully charged)	20 μ A
Operating	
TR and GSM inactive	75 mA
Additional current	
TR active	See datasheet of TR module
GSM transmitting	~175 mA
Accumulator charging	50 mA max.
Temperature range	
Operational	-20°C to +60°C
Accumulator charging	0 °C to +45 °C
Storage	-20°C to +20°C (1 year), -20°C to +60°C (1 month) +10°C to +25°C recommended
IQRF	
Frequency bands	For (DC)TR-52D: 868 MHz or 916 MHz (SW configurable) For (DC)TR-72D: 868 MHz
RF output power	According to TR module, programmable
TR module	(DC)TR-72DA or DCTR-52DA
Antenna	PCB antenna built-in TR module
GSM	
Frequency bands	850/900/1800/1900 MHz
Antenna	External, SMA, gain 2.15 dBi
Flash memory	SST25VF080B, 8 Mb, 100 000 erase/write cycles typ.
Dimensions	
Without antenna	87 mm x 62 mm x 26 mm
With antenna	105 mm x 62 mm x 62 mm
Weight	88 g

Absolute maximum ratings

Stresses above those values may cause permanent damage to the device. Exposure to maximum rating conditions for extended periods may affect device reliability.

Supply voltage (VCC)	5.5 V
Storage temperature	-20 °C to +60 °C

Hardware



Power supply

GW-GSM-02A is intended to be supplied by external stabilized 5 V DC connected to micro USB connector.

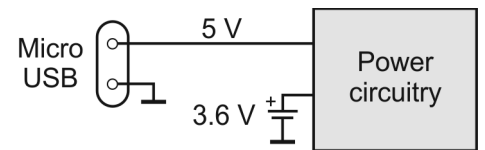

GSM

850 MHz and 1800 MHz as well as 950 MHz and 1900 MHz bands are used.

Pushbuttons

Both Reset and Control pushbutton functionality is fixed and can not be changed in application program.

Control

- Short press (< 1 s): No effect
- Long press (> 1 s): Switching On/Off. See Appendix 1 for startup LED indication.
- Long press (> 10 s): Restore the factory settings of the gateway. (After 10s LED stop flashing to indicate that new settings was written)

Reset

Reset button can be pressed by a pin through the hole in the case. It is intended to completely initialize the gateway.

LEDs

See Appendix 1 – LED indication.

IQRF

DCTR-52DA or (DC)TR-72DA wireless transceiver module is used for IQRF connectivity. Antenna is built in TR module.

Interferences between close GSM and IQRF frequencies can possibly result in packets losts. If this phenomena affects functionality of your gateway, to avoid simultaneous GSM / IQRF data transmissions you can separate both transmissions by an adjustable time-delay in the gateway setting. Or use remote GSM antenna instead of the standard one delivered with the gateway.

Flash memory

Log data is stored in circular buffer in Flash memory. When it is full and a subsequent write is performed, then it starts overwriting the oldest data.

There is 256 KB dedicated to IQRF RX data and 128 KB for IQRF TX data and same size for System log.

The number of records of IQRF RX/TX data depends on the parameter `Packet size`, which define how many payload data bytes is dedicated for every data record. For default setting (`Packet size = 64 B`) there is 3360 positions for IQRF RX and 1680 positions for IQRF TX. For System log there is always 6553 positions in the buffer.

The actual size of the data log is the `Packet size + 14 B`, where the additional 14 bytes are used for saving date, time and index of the log. In this way the user can calculate actual number of positions in the buffer.

Data volumes and recording frequency must be taken in account with respect to the Flash memory endurance.

When the `Packet size` is changed in the GW settings, all logs are cleared.

Case

Caution: It is not allowed to open the GW case otherwise the device may be damaged.

Operation

Start up

GW-GSM-02A is turned on by power supply connecting to USB connector or by the Control button.

Initialization

- After the start-up, the GW checks its own hardware first. If there is no critical error it starts to initialize GSM. When a critical error occurs, the execution does not continue and the error code is indicated by LEDs.

Communication

The size of payload IQRF data transmitted between the GW and the IQRF network is limited to 64 B in both directions.

GW-GSM-02A can communicate with an IQRF Cloud only. See chapter *IQRF Cloud*.

- All incoming IQRF data (IQRF RX) is stored and logged in internal Flash memory. The logged data is transmitted to the Cloud server always after the Cloud period elapsed. See chapters *IQRF IDE – GW Tool*.
- Data to be sent to IQRF (IQRF TX) is stored in the Cloud server first and transferred to the GW always after the IQRF Cloud period elapsing. After downloading the data from IQRF Cloud, it is stored in GW internal Flash memory and subsequently forwarded to IQRF network.
- If the communication between the GW and the Cloud server failed, the GW indicates an error.

Using IQRF IDE

- The IQRF IDE **GW Tool** is intended for GW configuration, checking of operational and error states and for access to the datalogger. When using the GW Tool, the communication with IQRF Cloud is enabled.
- IQRF IDE can also be used similarly as for the CK-USB-04(A): uploading the code into TR transceiver, configuration of TR module inside the GW, debugging of the application, using the IQMESH Network manager etc. In this mode the communication with IQRF Cloud is disabled.
- Additionally, GW firmware can be upgraded from IQRF IDE. See chapter *Firmware upgrade/Bootloader*.

GW configuration

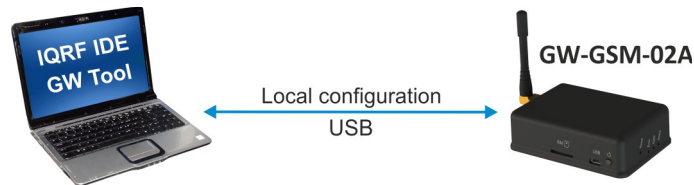

GW configuration is possible via IQRF IDE.

System log

All important events are logged. System logs can be read using IQRF IDE GW Tool.

Date and time

GW-GSM-02A contains a real time clock/calendar (RTCC). Date and time are synchronized using IQRF Cloud server.

TR module data exchange

Data between the internal TR module and the GW memory is transferred bidirectionally via SPI (using the `bufferCOM` memory array inside the TR module). Therefore, the application in TR must have the SPI communication activated. When using DPA, a plug-in with SPI interface must be uploaded in TR. The maximum SPI packet length is 64 B.

GW services

- HTTP client for communication with IQRF Cloud server (using the 128 b AES encryption)
- DHCP client for automated getting of IP address from the DHCP server

GW identification

IMEI

Every device can be identified using IMEI, which is the unique identifier of the GSM chip. The IMEI can be read using the GW Tool.

ID

Another unique number (manufacturer's identification) is used to identify the gateway by IQRF IDE, the IQRF Cloud server and user applications utilizing the Cloud via API.

For GW-GSM-02A ID = 11 xx xx xx, where xx xx xx are unique 6 digits, assigned by the manufacturer

IQRF Cloud

The IQRF Cloud provides an effective way to exchange data between IQRF wireless device(s) and a user superordinary system implemented by a higher level platform (e.g. PHP, JavaScript or web interface) and connected via Internet or a LAN.

As an interface to IQRF, the GW-GSM-02A or another IQRF gateway providing Internet connectivity (Ethernet, GPRS or WiFi) is intended.

An IQRF Cloud server is available free of charge on [http\(s\)://cloud.iqrf.org](http(s)://cloud.iqrf.org) provided by CIS (Complete Internet Services, s.r.o., an IQRF contractual partner for cloud implementations). Refer to the IQRF Cloud User's Guide for details.

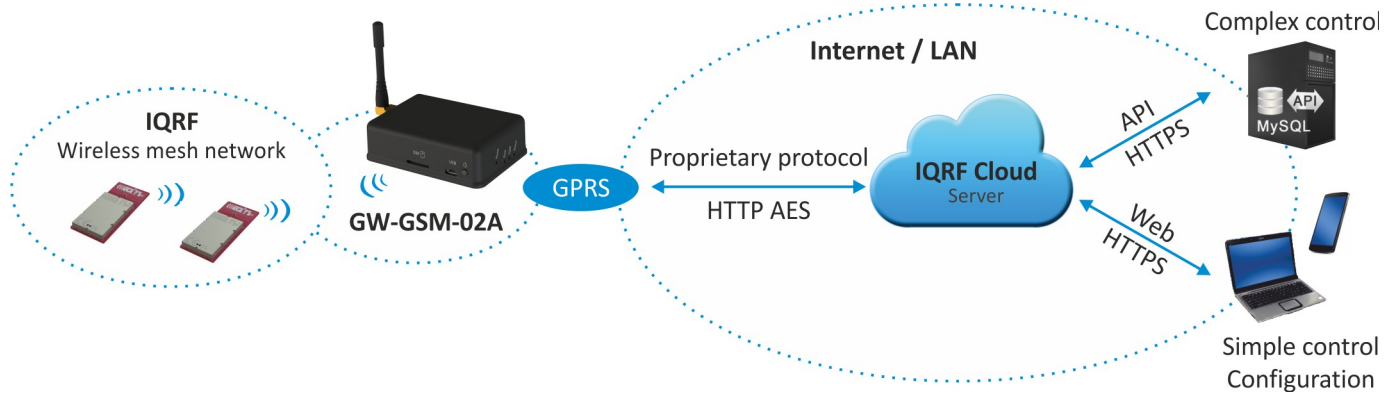

IQRF IDE – GW Tool

IQRF IDE 4.20 and higher is required.

Login to GW Tool

The GW Tool can be invoked from IQRF IDE menu Tools → GW Tool.



To open the Tool, the username and the password must be entered. Default values are `iqr` and `iqr`.

PIN code

The SIM card is locked by the PIN code. It must be specified during the first configuration. The following window will appear when PIN is not specified. It can also be invoked using the *Update* button. See below.

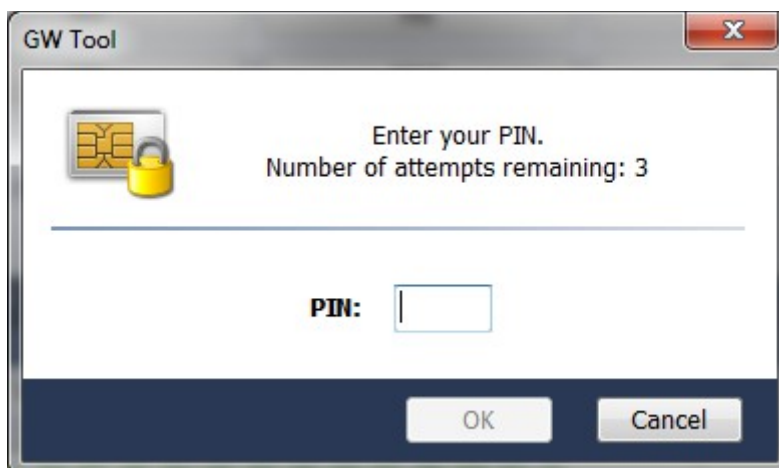

Status

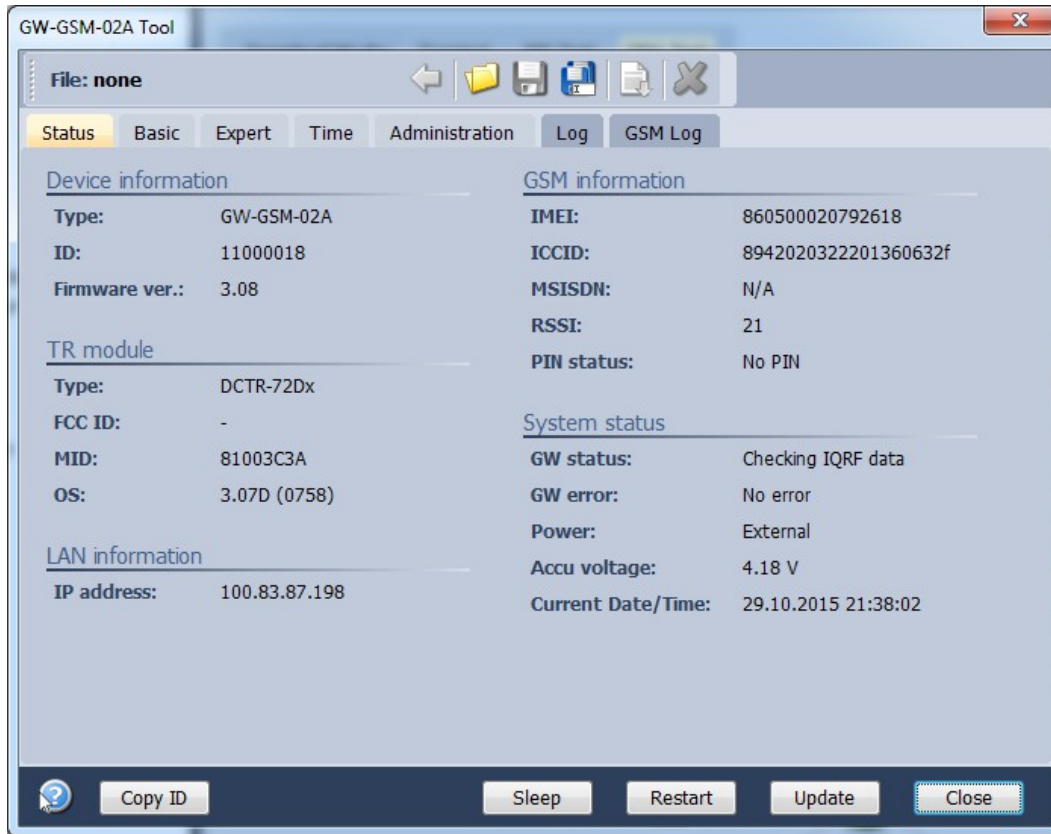

The *Status* tab contains general overview about the gateway status. Several buttons are available to control the GW:

- Copy ID To copy the GW ID to the clipboard
- Restart To restart the gateway
- Update To update the Status tab
- Close To close the GW Tool window

Device information

- Type Current GW type
- ID Unique identification number of the gateway
- Firmware ver. Current firmware version

TR module

- Type IQRF TR module type inside the gateway
- FCC ID FCC certification identification
- MID Unique IQRF TR module identification number
- OS IQRF OS version of the TR module

LAN information

- IP address Current IP of the GW

GSM information

- IMEI A unique number assigned to GSM chip inside the gateway
- ICCID A unique number assigned to the SIM card
- MSISDN A number uniquely identifying a subscription in a GSM network
- RSSI Received GSM signal strength indicator. The values correspond to the following gains:

RSSI value	Signal strength [dBm]
< 4	< -107
< 10	< -93
< 16	< -71
< 22	< -69
< 28	< -57
>= 28	>= -57
99	unknown

- PIN status
 - No PIN PIN is not used by the SIM card
 - Enter PIN The PIN needs to be inserted
 - Used PIN The PIN is correctly set
 - PIN blocked The PIN has been inserted incorrectly for the third time. When this situation occurs, the PUK must be used in another GSM device (in a cell phone for instance) to unblock the SIM card.

System status

- GW status Current operation executed by the gateway:
 - Initiating GSM
 - Initiating GPRS
 - Reading DNS
 - Server communication
 - Checking IQRF data
 - Sending IQRF data
 - Reading IQRF data
 - Checking GSM
 - Logging IQRF, GSM off
 - GW iddle
- GW error An error during execution indication:
 - No error
 - AT command error
 - SIM card error
 - SIM card blocked
 - Waiting for PIN
 - FLASH error
 - TR SPI Error
 - GSM init error
 - DNS error
 - GPRS init error
 - Cloud Server communication failed
 - Cloud password error
- Power External / Accumulator
- Accu voltage Accumulator voltage
- Current Date/Time The date and time used in the gateway

Basic

The *Basic* tab provides the setting of the gateway.

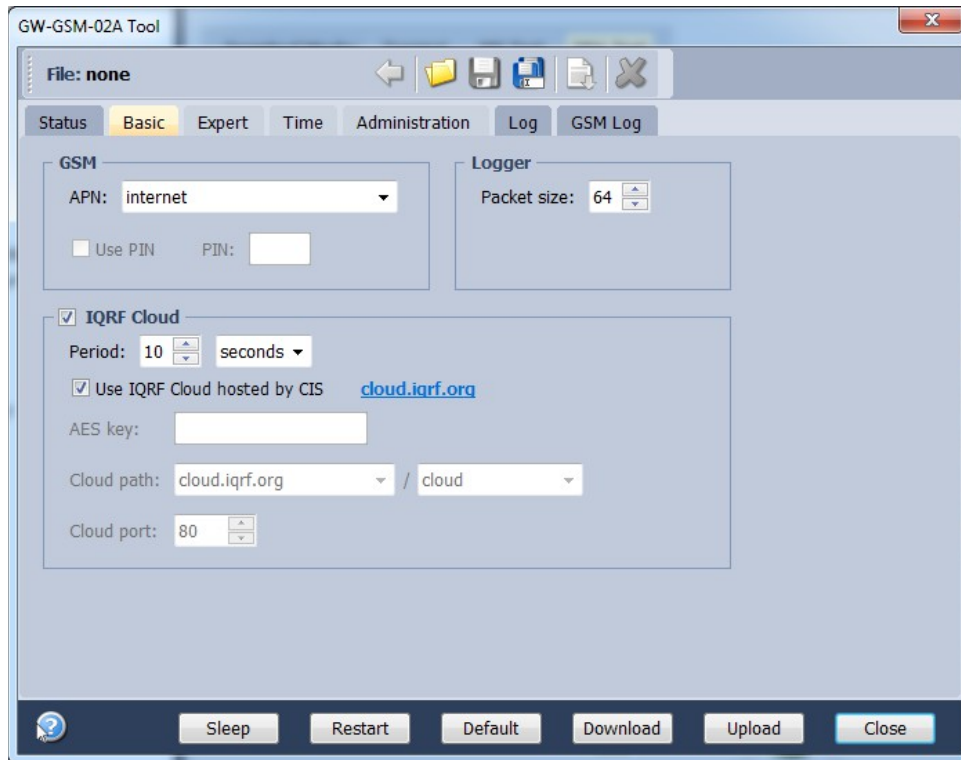

The following buttons are available in addition to previous ones:

- Restart To restart the GW with current configuration
- Default To restore the default configuration
- Download To read the configuration from GW
- Upload To store the configuration to GW

GSM

- APN The user must specify the APN according used GSM provider

Logger

- Packet Size The size dedicated for the data log in the gateway memory. By default, this value is set to 64 B, the same as the maximum size of the IQRF packet. Shorter packets allow to store more data logs. Minimum packet size is 1 B. When an IQRF packet oversized the selected packet size, a part of user data is lost.

When the packet size is changed the content of internal memory is cleared.

IQRF Cloud

- IQRF Cloud If this checkbox is not checked, the communication with IQRF Cloud is disabled and the gateway reads the data from IQRF side only.
- Period Defines how often the gateway transmits the data to IQRF Cloud server. Allowed values are from 10 s to 24 hours.
- Use IQRF Cloud hosted by CIS The gateway is configured by default to communicate with IQRF Cloud server provided by CIS. Any gateway can also communicate with another IQRF Cloud server provided by anyone else. In such a case, the checkbox must be unchecked and the following fields must be filled.
- AES key Encryption key used for secure communication between the gateway and the IQRF Cloud server. The same key must also be specified at the server side.
- Cloud path The URL address where IQRF Cloud server is hosted. The '/cloud' substring must follow
- Cloud port The TCP port used. In most cases port 80 is used.

Expert

The user does not need to modify this setting in most cases.

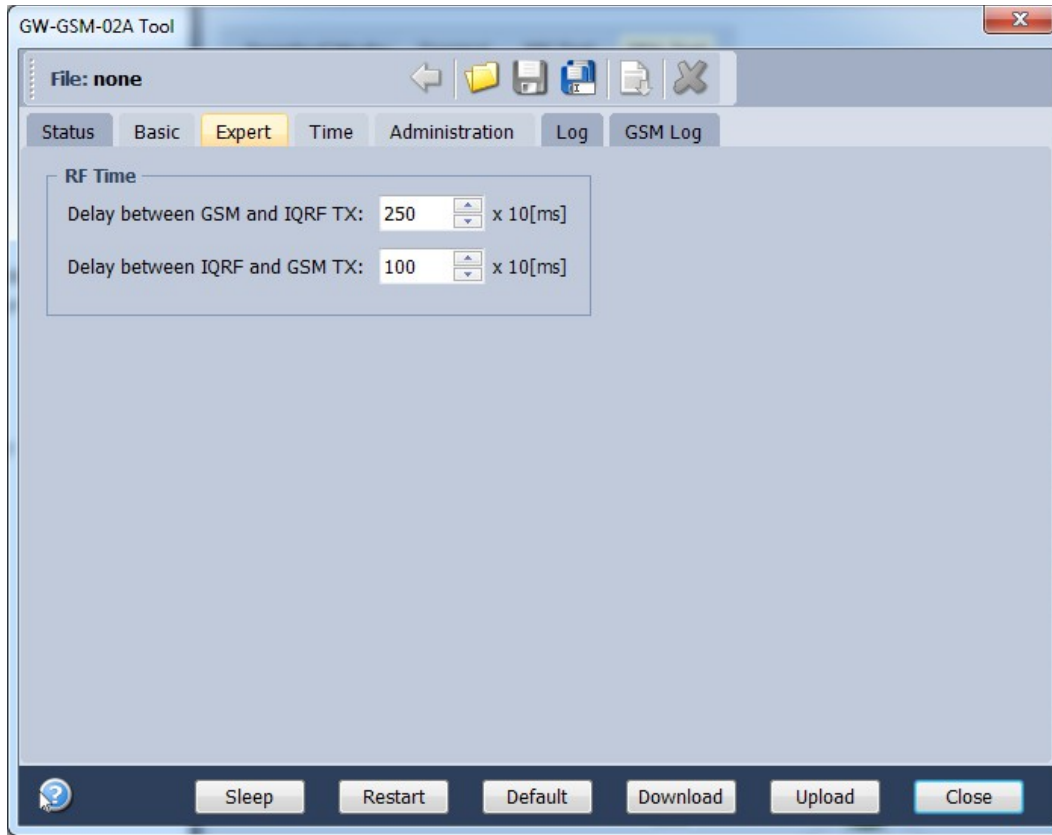

- Delay between GSM and IQRF TX
Sometimes, in case of bad IQRF RF conditions, GSM can affect the RX IQRF data when received simultaneously during GSM transmitting. Such a problem can be fixed by increasing this delay (to separate both events in time).
- Delay between IQRF and GSM TX
When DPA used, this delay can define time ensuring that all IQRF responses are received. This ensures that some responses are uploaded to the Cloud server with the next period. This is advantageous especially when the Cloud period is set long and user wants to receive the response shortly after the DPA request was sent.

Time

GW time and date setup.

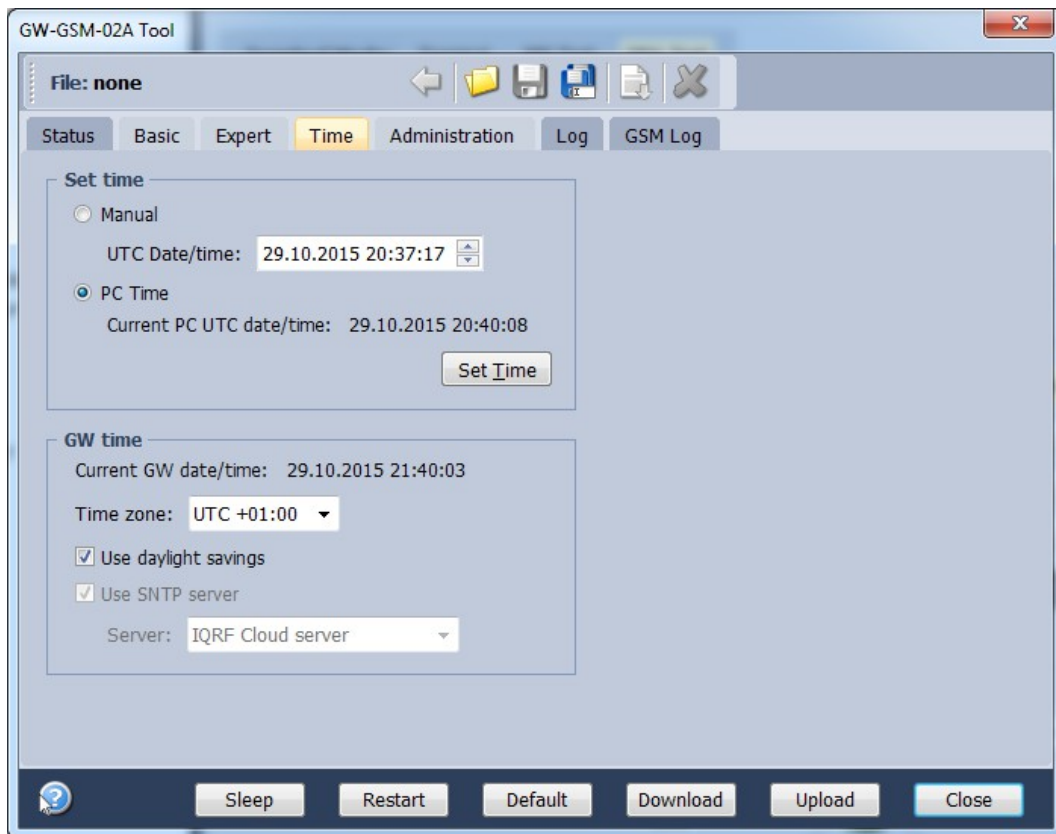

Set time

- Manual To setup the time manually
- PC time To upload the date and time from connected PC.

Selected time is transferred to the GW by the *Set Time* button.

GW time

- Current GW Date/Time Date and time currently running in the GW
- Time zone Time zone selection
- Use daylight savings Daylight savings for given time zone selection

Administration

The user can change the username and the gateway password here. When the password is changed, in order to allow an access the data on the Cloud server it must be changed there too. The change of username has no effect for that. Allowed password length is from 4 to 8 characters. When the username or the password is lost, the user can reset the gateway to factory settings. The default username and password values are `iqrf` and `iqrf`.

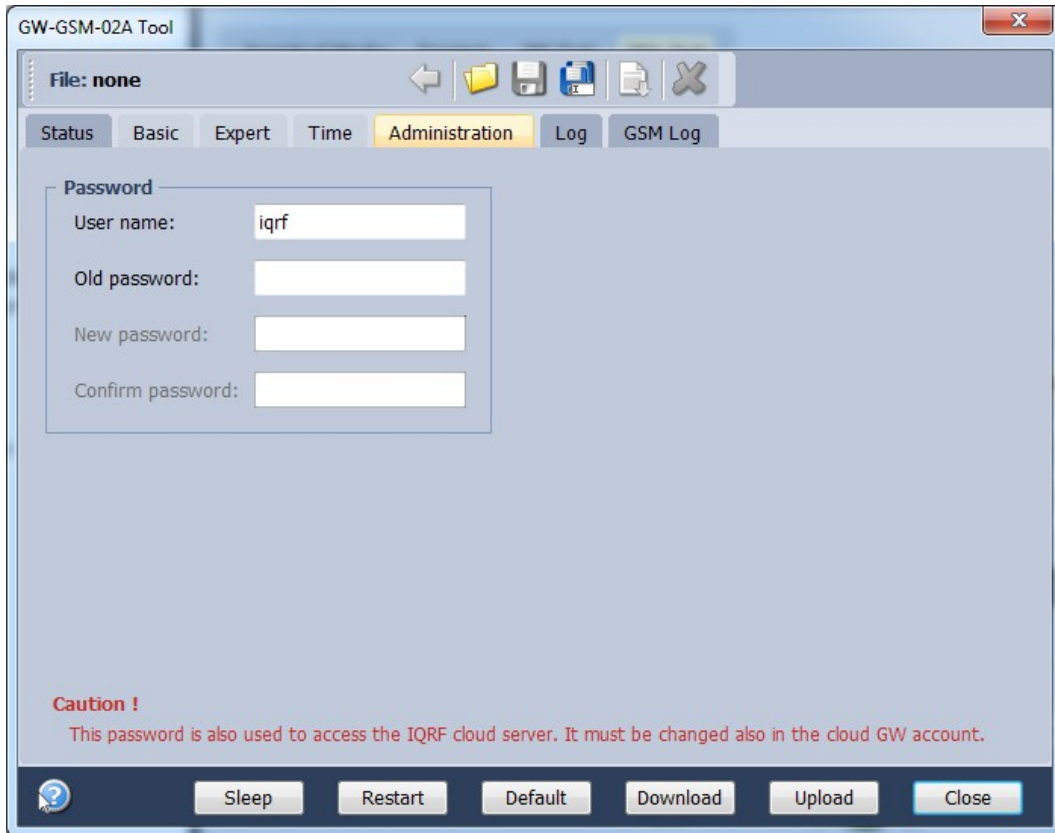

Log

Transmitted data stored on the Cloud server stays also accessible directly in the GW buffer.

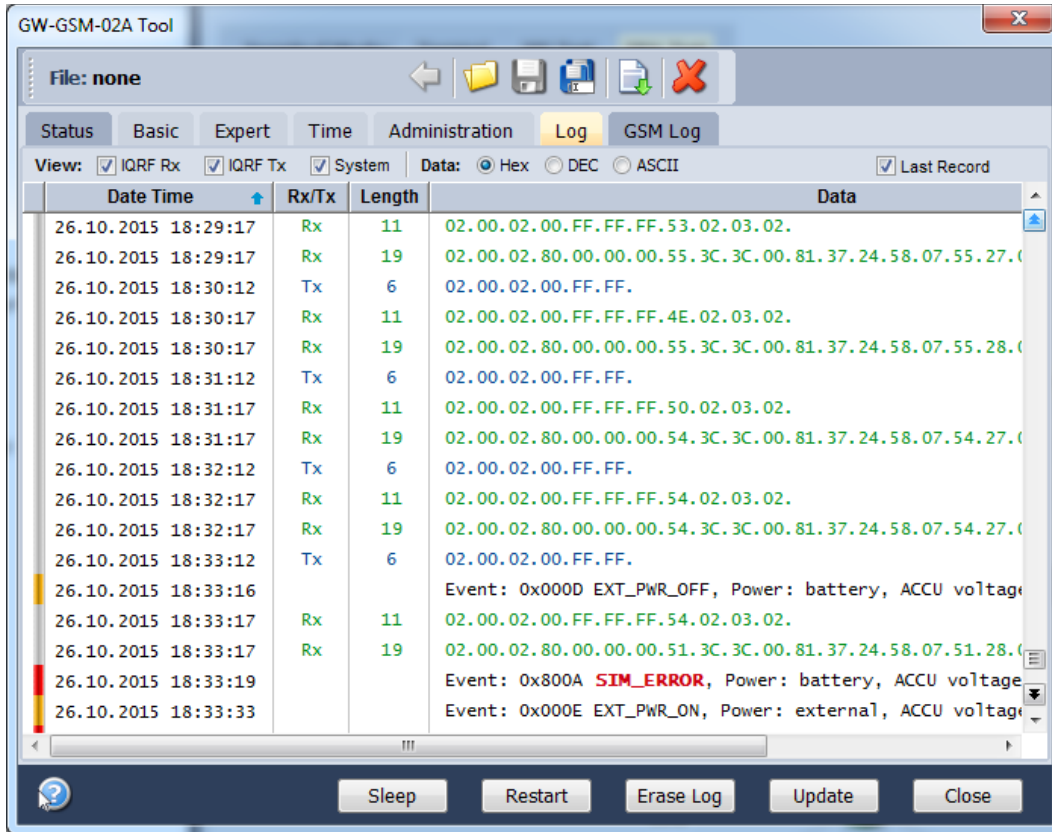

Buttons:

- Restart To restart the GW
- Erase Log To erase the content of the whole GW internal log memory
- Update To read the data from the GW and refresh the *Log* window
- Close To close the *GW Tool* window

Three types of logs are stored in the gateway:

- IQRF Rx Data received from IQRF network and transmitted to the Cloud server
- IQRF Tx Data downloaded from Cloud server and transmitted to IQRF network
- System Certain events that occurs during the execution. The user do not usually need to take care about it. Nevertheless it can be helpful in case of nonstandard behavior.

Last Record When selected, the output list is scrolled down to display the last acquired data.

The format of IQRF RX/TX data depends on the user application in TR (e.g. DPA or any user-specific protocol). The format of system log is fixed. It contains the following information:

The following system events are logged:

- GW_RESET
- GW_ON_BY_BUTTON
- GW_ON_BY_EXT_POWER
- GW_ON_BY_TR_MODULE
- GW_OFF_BY_BUTTON
- GW_OFF_BY_USB_COMMAND
- GW_OFF_BY_LOW_ACCU
- GSM_RESET
- EXT_PWR_OFF
- EXT_PWR_ON
- CLOUD_REGISTRATION_OK
- GSM_LOGIN_OK
- GPRS_INIT_OK
- GPRS_OK
- IQRF_SPI_OK
- ACCU_OK
- IQRF_SPI_ERROR
- DNS_ERROR
- CLOUD_CONNECTION_ERROR
- CLOUD_REGISTRATION_ERROR
- CLOUD_UPLOAD_ERROR
- CLOUD_DOWNLOAD_ERROR
- CLOUD_PWD_ERROR
- AT_ERROR
- SIM_ERROR
- GSM_LOGIN_ERROR
- GSM_START_ERROR
- GSM_RUN_ERROR
- GPRS_ERROR
- SIM_BLOCKED
- ACCU_LOW

The Log also contains the specifying information:

- Power Indicates whether the GW is powered from external power supply or internal accumulator at the moment of the event.
- ACCU voltage Indicates the voltage on the accumulator
- RSSI Indicates the GSM signal strength. See chapter *IQRF IDE – GW Tool, GSM information*.

GSM Log

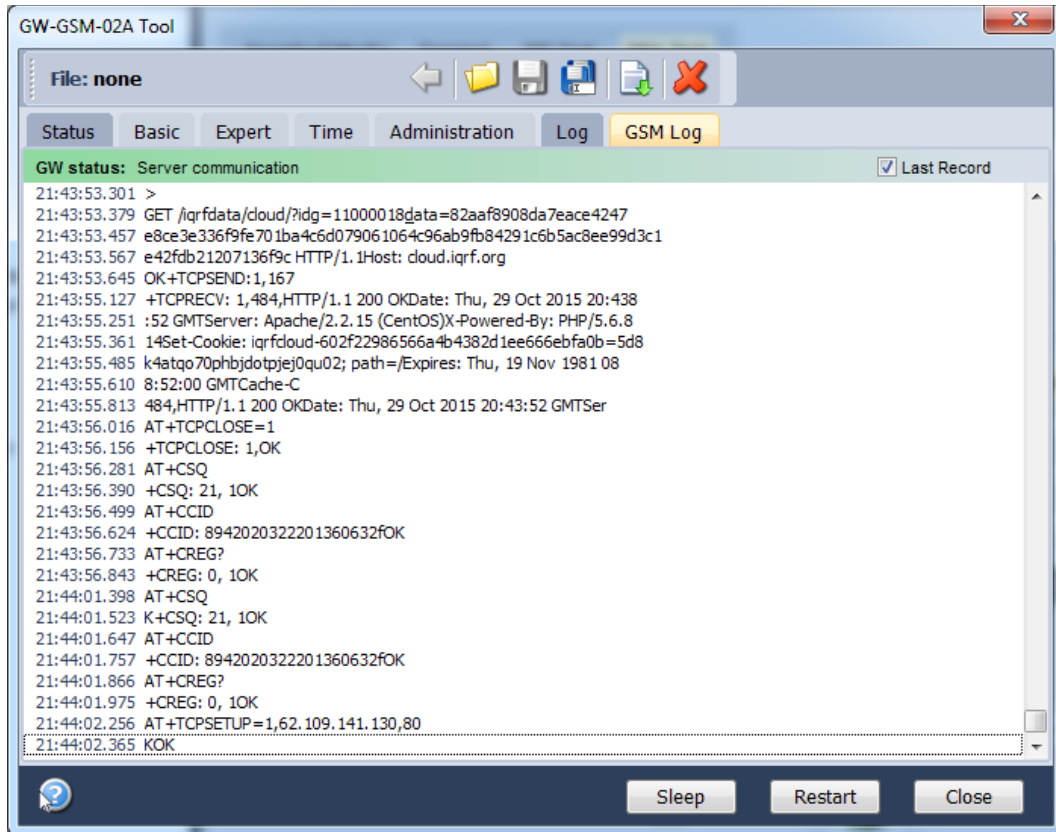

The GSM log displays the communication between the gateway and the GSM modem. Currently executed AT commands are displayed here. This may help the IQRF support to identify possible incorrect settings of the gateway etc.

Factory setup

This initial setup can be restored whenever the GW is powered from external source and the control button is pressed for more than 10 s. This can be useful if it is not possible to establish communication due to wrong configuration. See *Appendix 1 – LED indication*.

Basic

- Packet Size 64 B
- IQRF Cloud Communication Enabled
- Use IQRF Cloud Server hosted by CIS Enabled
- Communication period 30 s

Advanced

- Delay between GSM and IQRF TX 250 [in 10 ms units]
- Delay between IQRF and GSM TX 100 [in 10 ms units]

Password

- Authorization when enter the internal web server page, IQRF Cloud server or IQRF IDE GW Tool
 - Username „iqrif“
 - Password „iqrif“

Time

- Summer / winter time distinguishing On
- Time zone GMT + 01:00

First startup

Factory settings

GW-GSM-02A is set from the factory as follows:

- User name iqrfr
- Password iqrfr
- APN internet
- IQRF Cloud Enabled
- IQRF Cloud hosting By CIS (<https://cloud.iqrfr.org>)
- Communication period 30 s
- Delay between GSM and IQRF TX 250 [in 10 ms units]
- Delay between IQRF and GSM TX 100 [in 10 ms units]

This setting can be used to operate the GW with IQRF Cloud without any changes in configuration. But it is strictly recommended to change the GW password to avoid illegal access to GW data.

Step by step guide

To get familiar with GW-GSM-02A functionality, the IQRF module in the GW can be used with DPA hardware profile in similar way as described in IQRF DPA Quick Start Guide:

- Follow this Guide, chapters 1 to 5.
 - Use GW-GSM-02A instead of CK-USB-04(A)
 - GW-GSM-02A is delivered with the HWP-Coordinator-STD-SPI plug-in uploaded in internal TR module. Thus, there is no need to upload any HWP plug-in.
 - After the LED control (described in DPA Quick Start Guide) is done locally using IQRF IDE, test the same commands via IQRF Cloud:
 - Open the <https://cloud.iqrfr.org> page in web browser



- After creating a user account and login into the IQRF Cloud web page, the following page will appear:

	Id	Data	Macros	Redirect
1	0D00002D - GW-GSM-02	Show data / send command (4)	Edit macros (0)	
2	11000016 - GW-GSM-02A	Show data / send command (12)	Edit macros (2)	
3	12003F20 - Amper	Show data / send command (618476)	Edit macros (6)	Redirect
4	12003F78 - GW-ETH-02A	Show data / send command (2857)	Edit macros (1)	Redirect

- Add the GW to the List of gateways assigned to your account using *GATEWAY REGISTRATION / EDITING* menu. The GW ID and the password must be entered.
- Open the data page of the GW by clicking the *Show data / send command*.
- Click *Send command to gateway*. The window with predefined LED control commands opens.

Macros

Macros: LEDG ON LEDG OFF

Add macro

Add:

Index:

Data:

Gateway password:

Format:

Save

- Using the macros or by modification of commands in *IQRF Tx* field and the *Send* button you can control LEDs in individual or all nodes similarly as before (by using IQRF IDE).

Firmware upgrade / Bootloader

GW-GSM-02A has the bootloader implemented to upgrade the FW by a new version released by the IQRF manufacturer (.iqrffw file).

To upgrade the FW:

- Connect the GW to IQR IQRF IDE and open the *Device manager* in *Tool* option or press the F9 key
- Press the *Upload FW* button
- Browse the file with the new firmware
- Press the *Upload* button
- Wait until the upload is complete

Appendix 1 – LED indication

Run operation

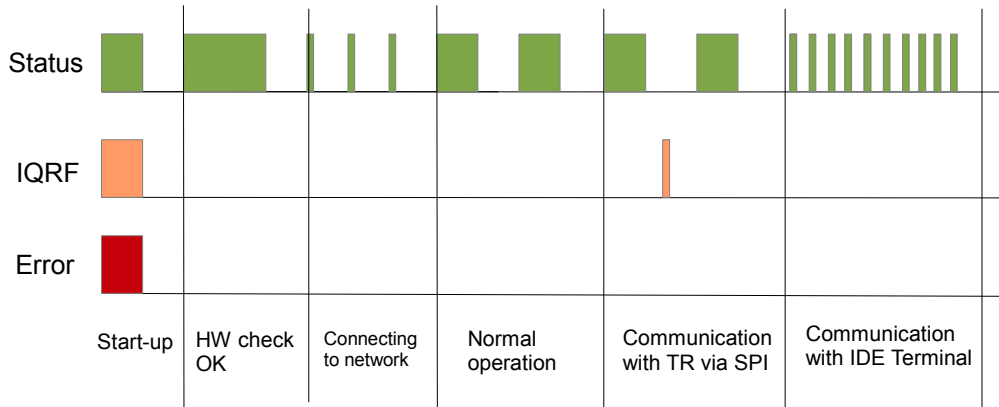

- When the gateway is started-up all LEDs are on for 1 s.
- After the start up the gateway performs a check of its hardware. If there is no problem in HW, the green LED is on for 2 s.
- After HW check, the gateway is connecting to GSM (and to Cloud server, if enabled). This is indicated by short flashing of green LED, 100 ms on / 1 s off.
- When the GW is successfully connected the green LED flashes 500 ms on / 500ms off. The GW works in normal mode.
- When the gateway is connected to IQRF IDE Terminal, the communication with IQRF Cloud is disabled (SPI communication is forwarded to the IDE Terminal). This mode is indicated by short flashes of green LED, 100 ms on / 100 ms off.
- When the GW Tool in IQRF IDE is open, the communication with IQRF Cloud is re-enabled. The GW works in normal mode.
- When the GW communicates with TR module, orange LED flashes for 10 ms.

For turning the GW off refer to chapter *Factory setting and turning the GW off* below.

Startup errors

After the start-up the GW performs hardware check. If there is a critical error prohibiting basic functionality, the GW stays in error state. This is indicated by red LED permanently on.



Startup error 0

- FLASH error Indicates an error of the FLASH memory

Startup error 3

- Accu low Indicates critically low level of the accumulator voltage. After 5 s the GW turns automatically off.

Run errors

If the gateway is at least partially operable or if an error occurs during its operation it continues the execution and indicates the run error.



During run error red LED is continuously on. Green LED flashes with the specific duty:

- Run error 1 10 ms on, 1 s off
- Run error 2 100 ms on, 100 ms off
- Run error 3 500 ms on, 500 ms off

Run error 1

- SIM error SIM card is not inserted or it is corrupted
- GSM start error GSM modem fatal error
- AT error GSM modem is not responding to AT commands
- Waiting PIN PIN code is not inserted
- SIM card blocked PUK code must be inserted
- GSM login error Connecting to GSM network not successful
- GPRS error GPRS connection not successful
- DNS error DNS service did not return an IP for specified URL
- Connection error Connection with cloud server not successful
- Registration error Registration to cloud server not successful
- Upload error Error when uploading data to cloud server
- Download error Error when downloading data from cloud server

When the gateway indicates Run error 1, it is not able to communicate with the Cloud server due to one of previous reasons, but it is still possible to receive and save data from IQRF side. To detect the Run error 1 type, the gateway must be connected to IQRF IDE with the Status tab opened where the error type can be read.

Run error 2

- IQRF SPI error IQRF TR module is not responding.

When the gateway signalize Run error 2, it is not able to communicate with the IQRF side, nevertheless the communication with IQRF Cloud server is not affected

Run error 3

- Run error 3 is not used in current FW.

Factory setting and turning the GW off

To restore the setting from the factory or to switch the GW off, the following procedure should be applied:

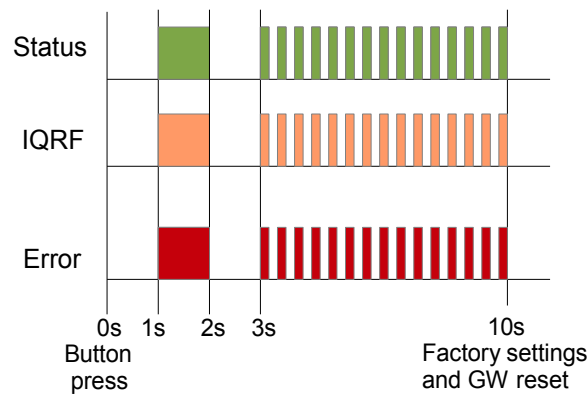

Factory settings

- At Time = 0 The user is pressing and holding the button.
- At Time = 1 to 2 s All LEDs are on.
- At Time = 2 to 3 s All LEDs are off.
- At Time = 3 s to 10 s All LEDs flashing 100 ms on, 100 ms .
- At Time = 10 s All LEDs are off, the GW factory setting is restored and the GW is reset.

Turning off

- If the button was released at time 0 s to 1 s, this procedure is canceled and the GW returns to run mode.
- If the button was released at time 1 s to 10 s, the GW is turned off.

Firmware upgrade

Once the *Upload* button is pressed the bootloader is started. This is indicated by turning all LEDs on and off for 1s. Then the content of the FLASH is erased and consequently new firmware is written. This is indicated by 20 Hz synchronous flashing of all LEDs. After the new firmware has been written, all LEDs are turned off and the GW is reset.

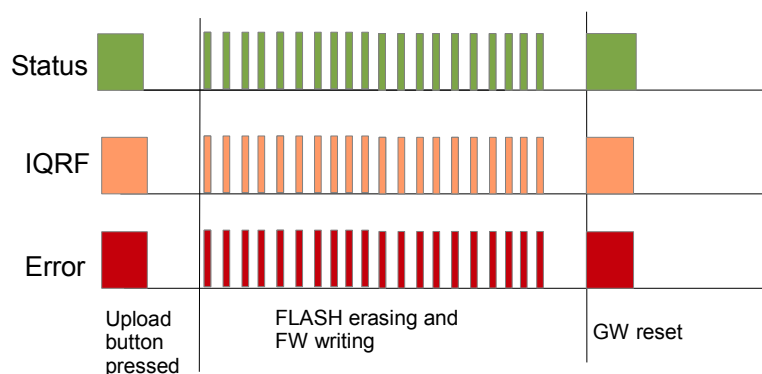

Product information

Pack list

- GW-GSM-02A gateway
- Accumulator 3.7 V, 700 mAh inside
- TR module (DC)TR-72DA or DCTR-52DA inside, with HWP-Coordinator-STD-SPI plug-in uploaded
- GSM antenna
- Power source TY-A6 (5V DC, 500 mA, with microUSB connector, compatible with cable CAB-USBABMICRO)
- MicroUSB cable CAB-USBABMICRO
- SD card

Ordering code

- GW-GSM-02A (72D) IQRF GSM gateway, (DC)TR-72DA inside.
- GW-GSM-02A (52D) IQRF GSM gateway, DCTR-52DA inside.

Hardware revision

- v1.05 GSM SIM connector with inverted logic.
- v1.04 Minor manufacturing optimization.
- v1.03 Minor changes in power supply circuitry.
- v1.02 EAP samples.

Firmware revision

- v3.11 For HW v1.05.
- v3.10 Faster SPI communication when used with TR-72D. Several minor improvements.
- v3.04 For HW v1.04. First stable release.
- v3.02 For EAP samples.

HW/FW compatibility

HW	FW			
	3.02	3.04	3.10	3.11
1.02	Yes	–	–	–
1.03	–	Yes	Yes	Yes
1.04	–	Yes	Yes	Yes
1.05	–	–	–	Yes

Document history

- 170814 TR module specification at page 3 changed. Updated for HW v1.05. Chapters *Hardware revision* and *Firmware revision* revised. Table *HW/FW compatibility* added.
- 160222 Bug in IQRF Cloud Period range fixed.
- 160125 Updated for FW v3.10, IQRF OS v3.07D, (DC)TR-72D and server hosting by CIS.
- 150129 Typo bug in `cloud.iqrf.org` address fixed. Preliminary.
- 141219 First release for firmware v3.01. Preliminary.

Sales and Service

Corporate office

IQRF Tech s.r.o., Prumyslova 1275, 506 01 Jicin, Czech Republic, EU
Tel: +420 493 538 125, Fax: +420 493 538 126, www.iqrf.tech
E-mail (commercial matters): sales@iqrf.org

Technology and development

www.iqrf.org
E-mail (technical matters): support@iqrf.org

Partners and distribution

www.iqrf.org/partners

Quality management

ISO 9001 : 2009 certified

Complies with directives 2011/65/EU (RoHS) and 2012/19/EU (WEEE).

Trademarks

*The IQRF name and logo are registered trademarks of IQRF Tech s.r.o.
PIC, SPI, Microchip and all other trademarks mentioned herein are property of their respective owners.*

Legal

All information contained in this publication is intended through suggestion only and may be superseded by updates without prior notice. No representation or warranty is given and no liability is assumed by IQRF Tech s.r.o. with respect to the accuracy or use of such information.

Without written permission, it is not allowed to copy or reproduce this information, even partially.

No licenses are conveyed, implicitly or otherwise, under any intellectual property rights.

The IQRF® products utilize several patents (CZ, EU, US)

On-line support: support@iqrf.org
