

## 1. Scope of Application

This data sheet is applied to the LED package, model CLL020-1203A1-50KL1A1.

## 2. Part code

$$\frac{\text{CLL 020}}{[1]} - \frac{\text{12 03}}{[2]} \frac{\text{A1}}{[3]} - \frac{\text{50}}{[4]} \frac{\text{K}}{[5]} \frac{\text{L1}}{[6]} \text{A1}$$

[1] Part Code

[2] Dies in series quantity

[3] Dies in parallel quantity

[4] Correlated color temperature

[5] Chromaticity range

[6] CRI

## < Features >

- External Dimensions: 13.5×13.5×1.4 mm
- Internal Structure: Aluminum Base Chip on Board
- Connection to Heat Sink: By M3 screw (Recommended)

- Luminous Flux: 835 lm @ 180 mA
- CCT: 5000 K
- CRI: Ra 65 typ.
- Thermal Resistance: 2.6 C/W

### - RoHS Compliant

- IEC62031 / Edition 1.0 / 2008 // LED modules for general lighting - Safety specifications Compliant
- IEC62471 / First Edition / 2006-07 // Photobiological safety of lamps and lamp systems / Exempt level
- IES LM-80

Symbol	CITLED
Name	CLL020-1203A1-50KL1A1
CITIZEN ELECTRONICS CO.,LTD. JAPAN	

### 3. Outline drawing - Marking

Unit : mm

Tolerances unless otherwise specified : +/-0.3

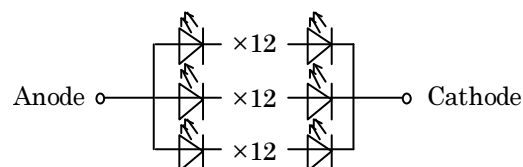
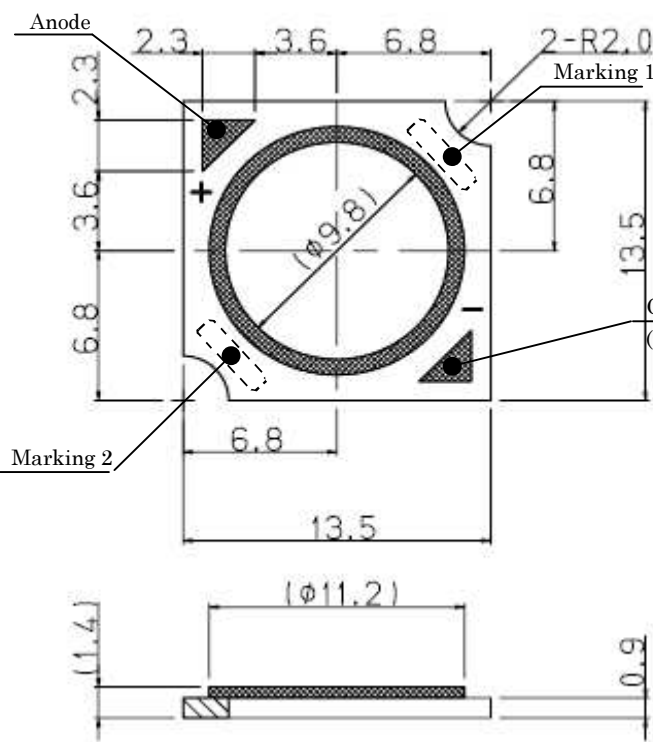

Marking 1 : Serial No.  
 Marking 2 : 12 03 50 L1

- └─ CRI : Ra 65 Typ.
- └─ Correlated color temperature : 5000K
- └─ Dies in parallel quantity : 3
- └─ Dies in series quantity : 12

### 4. Performance

#### (1) Absolute Maximum Rating

Parameter	Symbol	Rating Value	Unit
Input Power	$P_i$	16.0	W
Forward Current	$I_F$	360	mA
Reverse Current	$I_R$	1	mA
Operating Temperature	$T_{op}$	-30 ~ +85	C
Storage Temperature	$T_{st}$	-40 ~ +100	C
Case Temperature	$T_c$	100	C
Junction Temperature	$T_j$	150	C

\*1 Input power and forward current are the values when the LED is used within the range of the derating curve in this data sheet.

\*2 Refer to 3. Outline drawing for  $T_c$  measurement point

\*3 D.C. Current :  $T_j = T_c + R_j \cdot c \cdot X \cdot P_i$

Symbol	CITILED
Name	CLL020-1203A1-50KL1A1
CITIZEN ELECTRONICS CO.,LTD. JAPAN	

## (2) Electro-optical Characteristics

T<sub>c</sub>=25C

Parameter	Symbol	Condition	Min.	Typ.	Max	Unit
Forward Voltage	V <sub>F</sub>	I <sub>F</sub> =180mA	33.6	36.6	39.9	V
Luminous Flux	Φ <sub>v</sub>	I <sub>F</sub> =180mA	710	835	-	lm
CRI	R <sub>a</sub>	I <sub>F</sub> =180mA	-	65	-	-
Thermal Resistance	R <sub>j-c</sub>	Junction-Case	-	2.6	-	C/W

Chromaticity coordinates ( Condition : I<sub>F</sub>=180mA, T<sub>c</sub> = 25C)

	x	y
Center	0.3473	0.3717
a	0.3572	0.3919
b	0.3397	0.3775
c	0.3387	0.3528
d	0.3536	0.3646

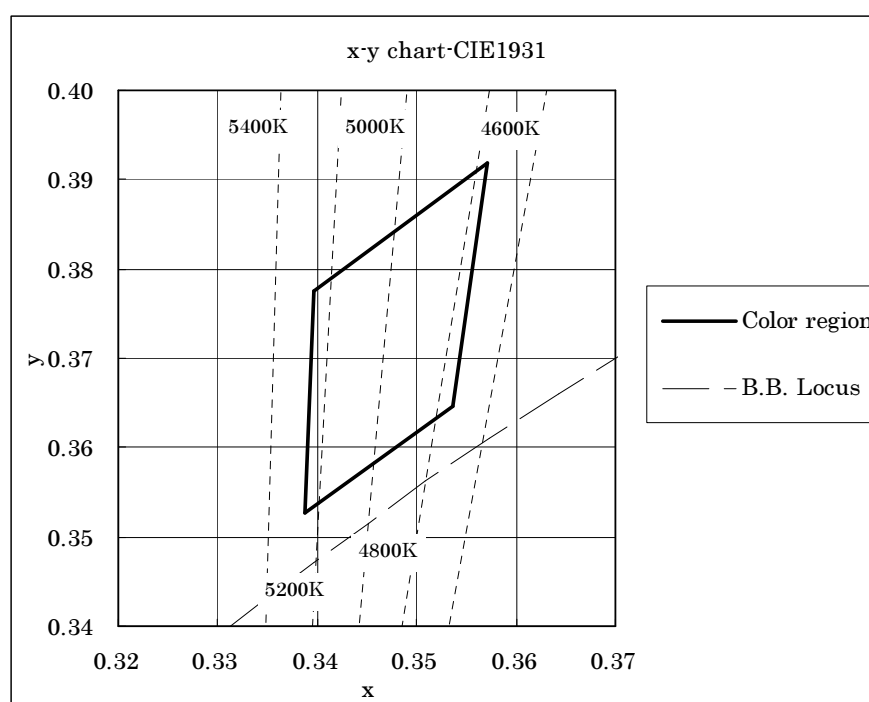

Note: The tolerance of measurement at our tester is V<sub>F</sub>+/-3% , Φ<sub>v</sub>+/-10% , Chromaticity(x,y)+/-0.005 and R<sub>a</sub>+/-1.

Symbol	CITILED
Name	CLL020-1203A1-50KL1A1
CITIZEN ELECTRONICS CO.,LTD. JAPAN	

## 5. Characteristics

Forward Current vs. Forward Voltage

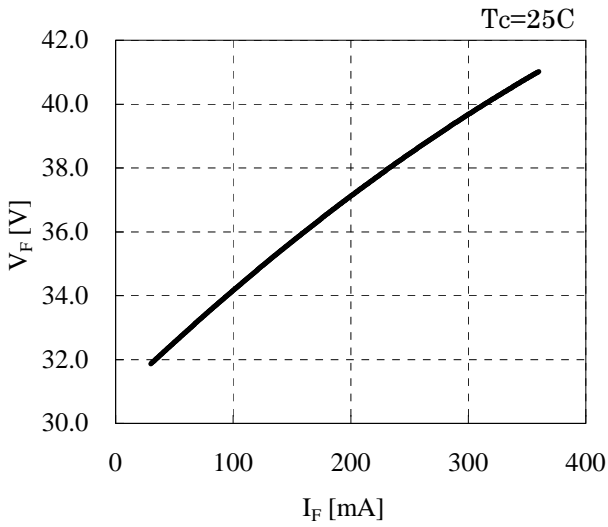

Forward Current vs. Relative Luminous Flux

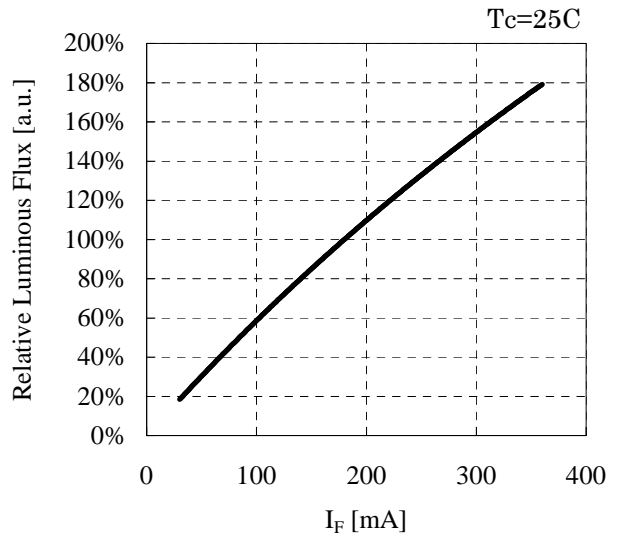

Forward Current vs. Chromaticity Coordinate

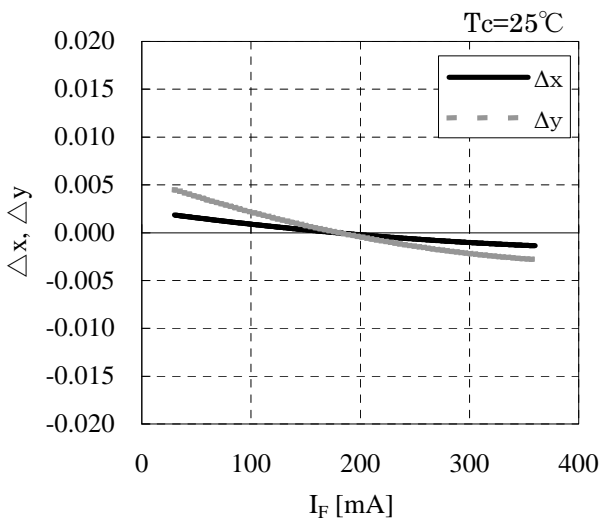

Case Temperature vs. Chromaticity Coordinate

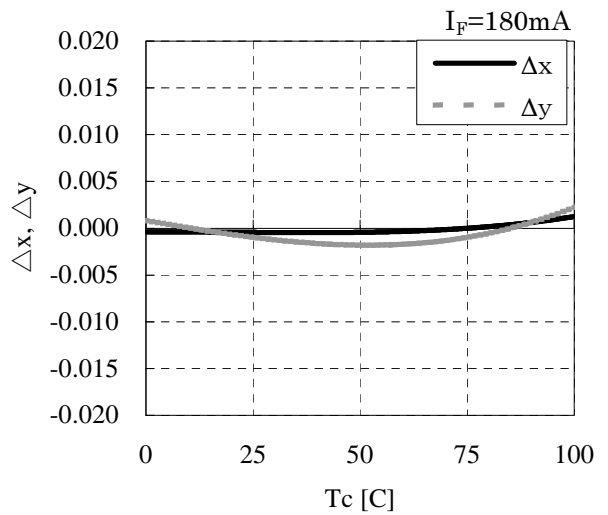

Symbol	CITLED
Name	CLL020-1203A1-50KL1A1
CITIZEN ELECTRONICS CO.,LTD. JAPAN	

Case Temperature vs. Forward Voltage  $I_F=180\text{mA}$

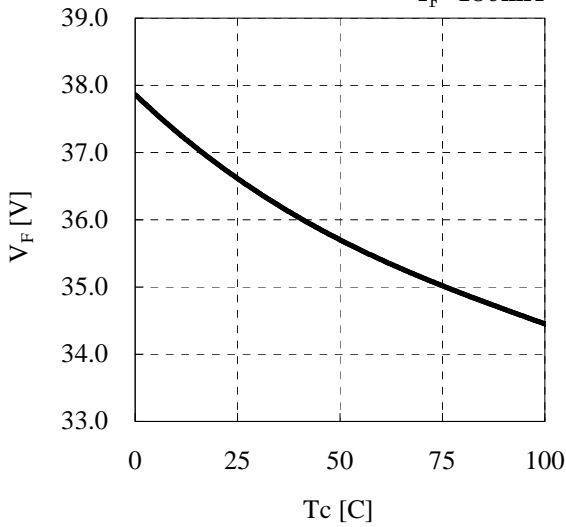

Case Temperature vs. Relative Luminous Flux  $I_F=180\text{mA}$

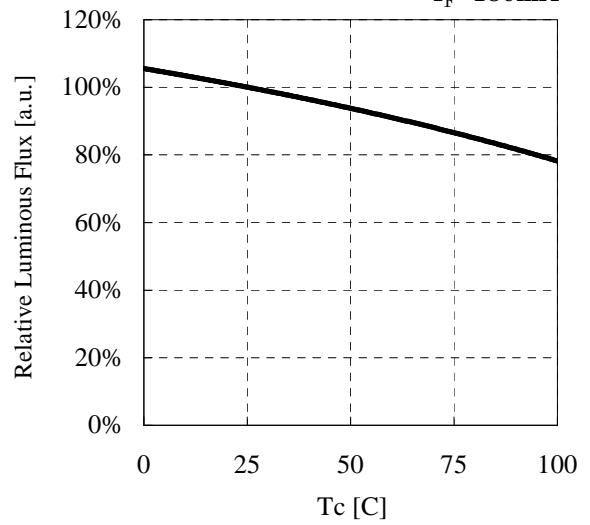

Case Temperature vs. Allowable Forward Current

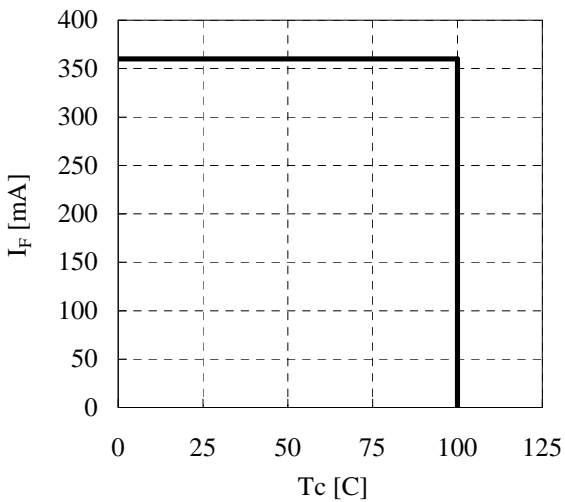

Spectrum

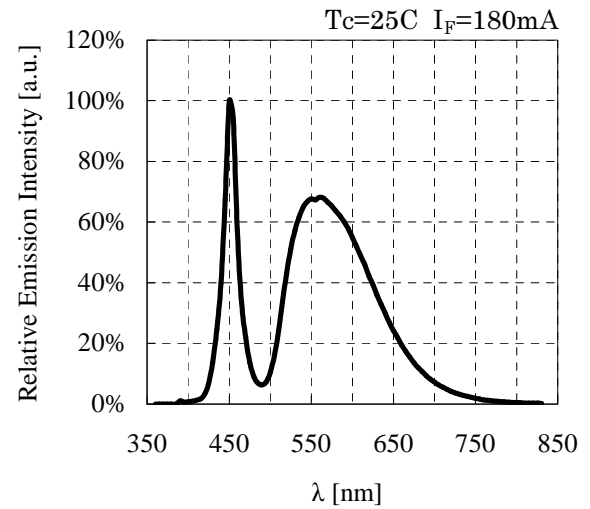

Directive Characteristic

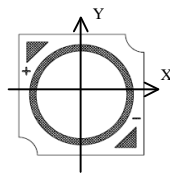
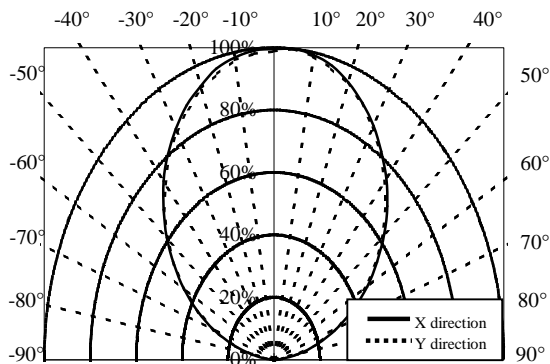

Symbol	CITLED
Name	CLL020-1203A1-50KL1A1
CITIZEN ELECTRONICS CO.,LTD. JAPAN	

# DATA SHEET

6/11

## 6. Reliability

### (1) Details of the tests

Test Item	Test Condition
Continuous Operation Test	Ta=25 C, I <sub>F</sub> =180 mA× 1000 hours(with Al-fin)
	I <sub>Fmax</sub> =360 mA Tjmax=150C× 1000 hours(with Al-fin)
Low Temperature Storage Test	-40 C × 1000 hours
High Temperature Storage Test	100 C × 1000 hours
Moisture-proof Test	85 C, 85 %RH for 500 hours
Thermal Shock Test	-40 C × 30 minutes – 100 C × 30 minutes, 100 cycle

### (2) Judgement Criteria of Failure for Reliability Test

(Ta=25C)

Measuring Item	Symbol	Measuring Condition	Judgement Criteria for Failure
Forward Voltage	VF	I <sub>F</sub> =180mA	>U X 1.1
Total Luminous Flux	Φ <sub>v</sub>	I <sub>F</sub> =180mA	<S X 0.85

U defines the upper limit of the specified characteristics. S defines the initial value.

Note : Measurement shall be taken between 2 hours and 24 hours, and the test pieces should be return to the normal ambient conditions after the completion of each test.

Symbol	CITILED
Name	CLL020-1203A1-50KL1A1
CITIZEN ELECTRONICS CO.,LTD. JAPAN	

## 7. Packing Specifications

### (1) Packing

An empty tray is placed on top of a six-tier tray which contain 54 pieces each. The set of seven trays is banded together with two rubber bands.

(Smallest packing unit: 324 pieces)

A label with product name, quantity, lot number is placed on the upper empty tray.

Tray (Dimensions: 310 × 210 × 12 mm / Materials: Electrically conductive PS)

< Packing figure >

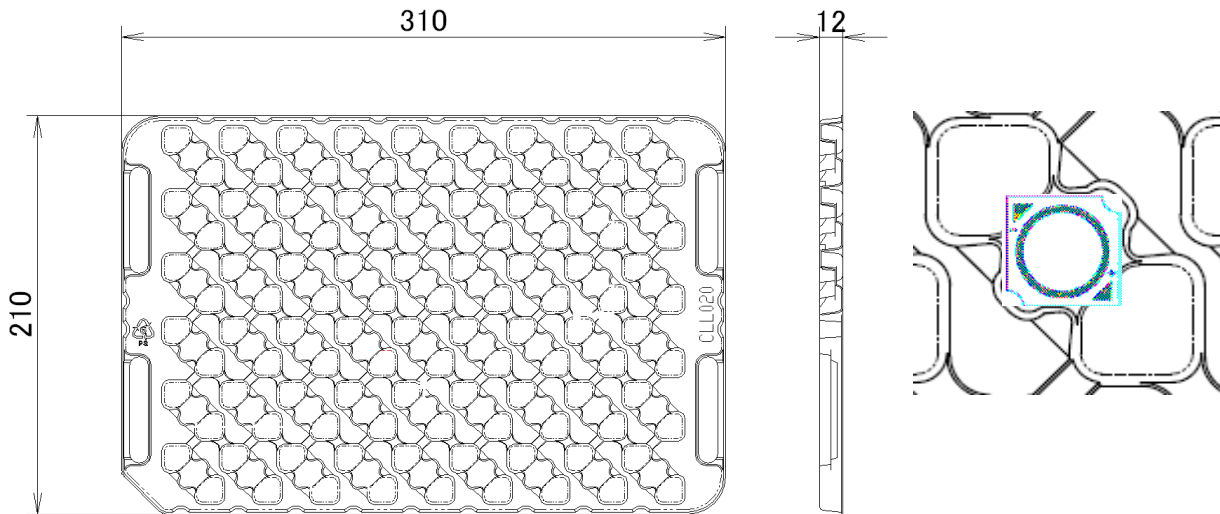

Product 54 pcs/tray

< Example of indication label >

CUSTOMER	
TYPE : CLL020-*****-*****-(1)	
P. NO : *****	---(2)
Lot No: *****	---(3)
Q'ty : ***	---(4)
CITIZEN ELECTRONICS	

1. TYPE e.g. CLL020-1203A1-50KL1A1
2. P.No. (Customer's P/N) e.g. 50008-010-1203303M1
3. Lot No.
  - First and second letter: Last digit of the year e.g. 11 : year 2011
  - Third letter: Production month e.g. 8 : August
  - Note: October, November and December are designated
  - Forth letter: CE's control number e.g. 5035
4. Quantity

Symbol	CITILED
Name	CLL020-1203A1-50KL1A1
CITIZEN ELECTRONICS CO.,LTD. JAPAN	

## 8. Precautions

1. Avoid the application of any stress to the resin portion.
2. Avoid any contact by a sharp metal nail or other materials with the resin portion.

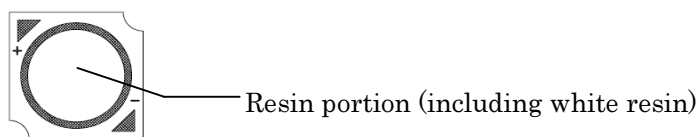

### 3. Precautions for product assembly

- When the LED package is attached to the heat sink by M3 screws, please be careful not to apply too much stress to the LED package. For example, fix the screws firmly after temporarily fixing them.
- Attachment to heat sink conditions such as tightening torque for screws should be optimized in accordance with the specifications for heat sinks. In addition, asperity or burrs harms the thermal connection between the LED package and heat sink. So please ensure correct contact to keep both thermal and mechanical connection.

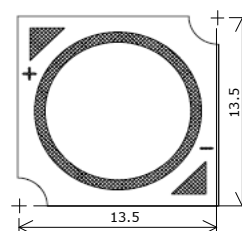
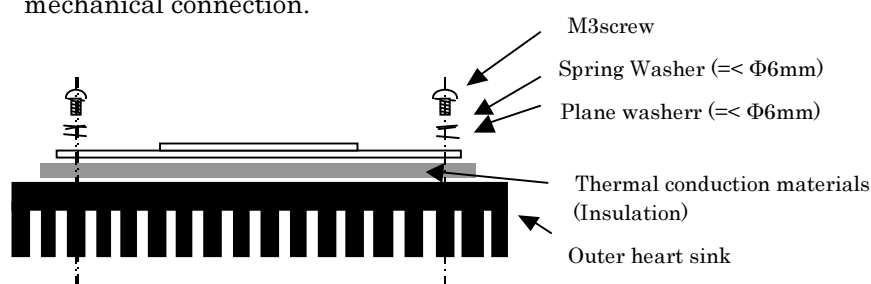

Recommended installation screw pitch

4. Insulation of the thermal section from the heat sink section of the LED has been confirmed up to 500V. However, for voltages higher than 500V, the customer should confirm the level of insulation themselves or contact Citizen Electronics. With regard to insulation after this product has been assembled in an apparatus, preventive action should be carried out by the customer.
5. For fixing this product to the outer heat sink, heat grease should be applied to the whole rear deformation when conducting the clamping operation with heat grease in sheet form.
6. Handling of static electricity
  - These products are sensitive to static electricity charge. Please take measures to prevent any static electricity being produced such as the wearing of a wristband or anti-static gloves when handling this product.
  - All devices, equipment and machinery must be properly grounded. It is recommended that precautions be taken against surge voltage to the equipment that mounts the LEDs.
  - ESD sensitivity of this product is 1000V (HBM, based on JEITA ED-4701/304).
  - When inspecting the final products in which LEDs were assembled, it is recommended to check whether the assembled LEDs are damaged by static electricity or not.
  - It is easy to find static-damaged LEDs by a light-on test.

Symbol	CITILED
Name	CLL020-1203A1-50KL1A1
CITIZEN ELECTRONICS CO.,LTD. JAPAN	



## 8. Precautions (continued)

### 7. Lighting at a low current

A minimum current value of lighting of all dice is 15mA.

When a minimum current is applied, LED dice may look different in their brightness due to the individual difference of the LED element, and it is not a failed product.

8. Please be aware that this product should not come into contact with any other parts in assembled status.

### 9. Drive circuit

- A constant current circuit is recommended as a drive circuit.

And when two or more LED packages are connected, the series connection between each package is recommended.

- Please design a circuit that prevents any reverse voltage (excess current) from being applied to this product instantaneously when the circuit is ON or OFF.

### 10. Heat generation

- As this product is designed with consideration of the heat release property of module, a heat release design is required to use this product efficiently.

Please ensure that heat generation is not in excess of the absolute maximum rating. (Refer to 4-1 Performance)

- Factors responsible for an increase in temperature include heat generation attributed to ambient temperature conditions or power dissipation. Thus, drive conditions should be taken into consideration, depending on ambient temperature (Ta).

### 11. Recommended soldering condition (This product is not adaptable to reflow process)

- Manual soldering

- Soldering shall be implemented using a soldering bit of 40W or less with a temperature 350°C or less within 3.5 seconds for one land.

(Recommended condition in a case of lead-free solder condition)

- No external force shall be applied to resin part during soldering.

- Next process of soldering should be carried out after the product has returned to ambient temperature.

- For soldering correction

- Regarding soldering correction, above conditions shall be used.

- Contacts number of soldering bit should be within twice for each terminal as a correction.

\* Citizen Electronics cannot guarantee if usage exceeds this recommended conditions.

Please use it after sufficient verification is carried out on your own risk if necessary.

Symbol	CITILED
Name	CLL020-1203A1-50KL1A1
CITIZEN ELECTRONICS CO.,LTD. JAPAN	

## 8. Precautions (continued)

### 12. Eye Safety

- The International Electrical Commission (IEC) published in 2006 IEC 62471 "2006 Photobiological safety of lamps and lamp systems" which includes LEDs within its scope. When sorting single LEDs according to IEC 62471, most white LEDs can be classified as belonging to either Exempt Group or Risk Group 1.
- However, Optical characteristics of LEDs such as radiant flux, spectrum and light distribution are factors that affect the risk group determination of the LED, and especially a high-power LED, that emits light containing blue wavelengths, may have properties equivalent to those of Risk Group 2.
- Great care should be taken when directly viewing an LED that is driven at high current, has multiple uses as a module or when focusing the light with optical instruments, as these actions may greatly increase the hazard to your eyes.
- It is recommended to regard the evaluation of stand-alone LED packages as a reference and to evaluate the customer's final product.

13. The use of Class 2 power supply is assumed for this product.

14. If the product might to be used under the following conditions, the customer must evaluate its appropriateness them. This product is not designed for use under the following conditions. in places where the product might:

- get wet due to rain
- suffer from damage caused by salt.
- be exposed to corrosive gas such as Cl, H<sub>2</sub>S, NH<sub>3</sub>, SO<sub>2</sub>, Nox and so on.
- be exposed to dust, fluid or oil.

Symbol	CITLED
Name	CLL020-1203A1-50KL1A1
CITIZEN ELECTRONICS CO.,LTD. JAPAN	

## 9. Precautions with regard to product use

1. This document is provided for reference purposes only so that CITIZEN ELECTRONICS' products are used as intended. CITIZEN ELECTRONICS neither makes warranties or representations with respect to the accuracy or completeness of the information contained in this document nor grants any license to any intellectual property rights or any other rights of CITIZEN ELECTRONICS or any third party with respect to the information in this document.
  
2. All information included in this document such as product data, diagrams, charts, is current as of the date this document is issued.  
Such information, however, is subject to change without any prior notice.  
Before purchasing or using any CITIZEN ELECTRONICS' products listed in this document, please confirm the latest product information with a CITIZEN ELECTRONICS' sales office, and formal specifications must be exchanged and signed by both parties prior to mass production.
  
3. CITIZEN ELECTRONICS has used reasonable care in compiling the information included in this document,  
but CITIZEN ELECTRONICS assumes no liability whatsoever for any damages incurred as a result of errors or omissions in the information included in this document.
  
4. Absent a written signed agreement, except as provided in the relevant terms and conditions of sale for product, and to the maximum extent allowable by law, CITIZEN ELECTRONICS assumes no liability whatsoever, including without limitation, indirect, consequential, special, or incidental damages or loss, including without limitation, loss of profits, loss of opportunities, business interruption and loss of data, and disclaims any and all express or implied warranties and conditions related to sale, use of product, or information, including warranties or conditions of merchantability, fitness for a particular purpose, accuracy of information, or no infringement.
  
5. Though CITIZEN ELECTRONICS works continually to improve products' quality and reliability, products can malfunction or fail. Customers are responsible for complying with safety standards and for providing adequate designs and safeguards to minimize risk and avoid situations in which a malfunction or failure of a product could cause loss of human life, bodily injury or damage to property, including data loss or corruption.  
In addition, customers are also responsible for determining the appropriateness of use of any information contained in this document such as application cases not only with evaluating by their own but also by the entire system.  
CITIZEN ELECTRONICS assumes no liability for customers' product design or applications.
  
6. Please contact CITIZEN ELECTRONICS' sales office if you have any questions regarding the information contained in this document, or if you have any other inquiries.

CITIZEN Micro HumanTech is a registered trademark of Citizen Holding Co., Japan.

CITILED is a registered trademark of CITIZEN ELECTRONICS CO., LTD. Japan

Symbol	CITILED
Name	CLL020-1203A1-50KL1A1
CITIZEN ELECTRONICS CO.,LTD. JAPAN	