

2

1

Extrusion

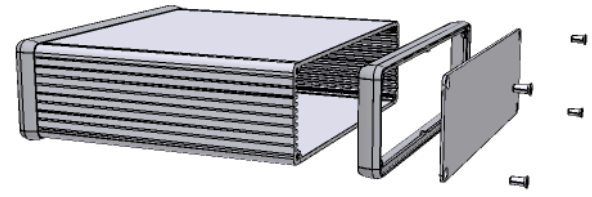
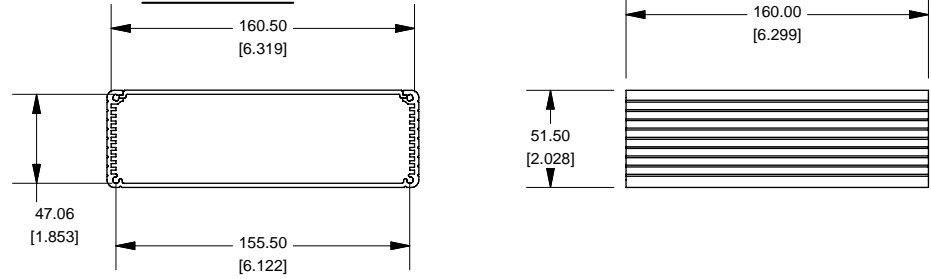

EXTRUSION DESIGNED FOR 160MM WIDE P BOARD

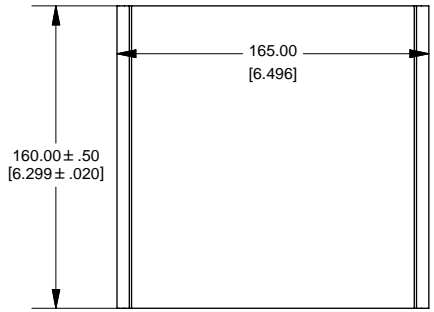

Slot Details

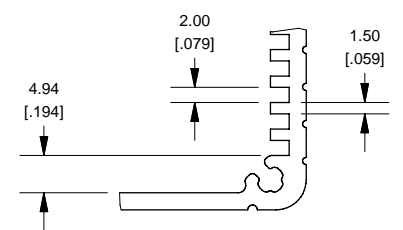

End Plate

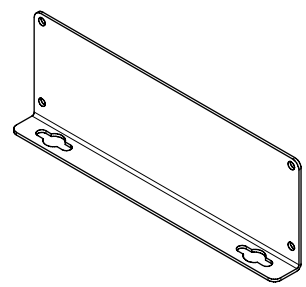
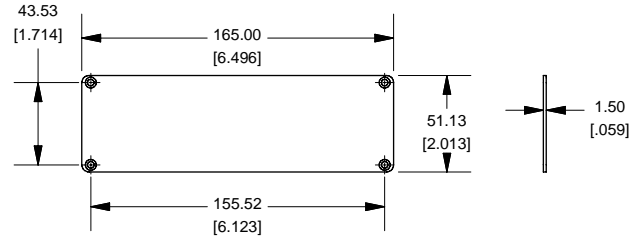

**OPTIONAL FLANGE END PANELS
1455TF**

Open Bezel

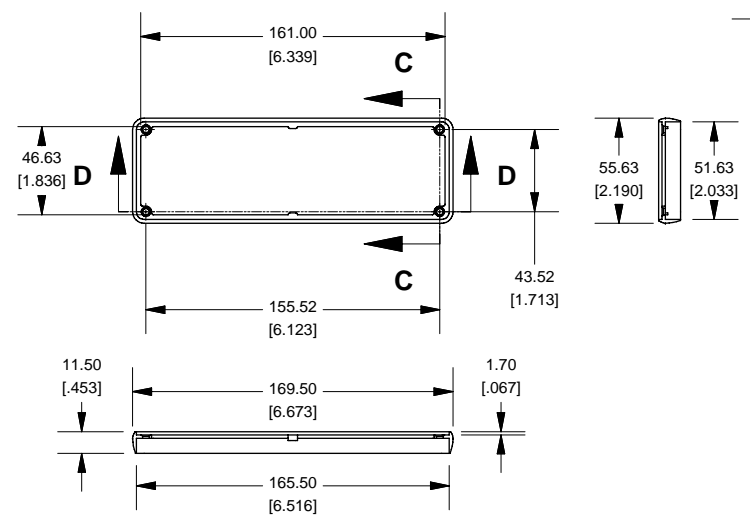

NOTE
 Purchased assembly includes box, plastic bezels, end panels, #6 Taptight screws and self adhesive rubber feet.
 Box made from Extruded Aluminum 6063.
 Bezels made with polycarbonate.

| 1455T1601 | |
|------------------------------|-------------|
| PART NUMBERS | |
| Clear Anodized | 1455T1601 |
| Black Anodized | 1455T1601BK |
| ACCESSORIES | |
| See website for accessories. | |

**HAMMOND
MANUFACTURING™**

1455T1601
www.hammondmfg.com

Enclosures can be Factory Modified (Milling, Drilling, Printing etc.)
 Solid models of this enclosure available in STEP or IGES.
 Contact Factory mjm@hammondmfg.com

2

1